

# CBS ArcSafe®

*Distance Is Safety®*

A Group CBS Company

## RRS-1

Remote Racking System



**Distance is Safety®**

WHAT STANDS  
BETWEEN YOU AND  
ARC-FLASH DANGER?

**WE  
DO.**

2616 Sirius Road | Denton, TX 76208 | (877) 4-SAFETY | [www.cbsarcsafe.com](http://www.cbsarcsafe.com)

Rev. 12/16/2016

Technical Manual

### **RRS-1 – Universal Remote Racking System (Rotary)**

The CBS ArcSafe® RRS-1 is a universal remote racking system capable of remotely installing and removing rotary style draw out circuit breakers without requiring any modification to the existing switchgear. Operation of the simple to use RRS-1 is quite intuitive and requires only minimal setup. When used properly, the RRS-1 allows technicians to remain outside of the arc flash boundary during the potentially dangerous racking operation.

### **RRS-2 – Universal Remote Racking System (Non-Rotary)**

The CBS ArcSafe® RRS-2 is a universal remote racking system capable of remotely installing and removing non-rotary style draw out circuit breakers without requiring any modification to the existing switchgear. Operation of the simple to use RRS-2 is quite intuitive and requires only minimal setup. When used properly, the RRS-2 allows technicians to remain outside of the arc flash boundary during the potentially hazardous racking operation.

### **RRS-3 – Application Specific Remote Racking System (Rotary And Non-Rotary)**

The CBS ArcSafe® RRS-3 product line is made up of various application specific remote breaker racking devices. Each standalone system allows service personnel to remotely install and remove a particular type of circuit breaker safely while stationed safely outside of the arc flash boundary during the potentially dangerous operation. The lightweight and compact design of the RRS-3 systems makes them ideal for hard to access areas where space is at a premium.

### **RRS-4 – PLC Based Universal Remote Racking System (Rotary)**

The CBS ArcSafe® RRS-4 universal remote racking system is an updated PLC based version of the best selling RRS-1. The dual mode, source programmable, PLC based control system offers two different operating modes to choose from based on user preference or the application. The RRS-4 is capable of remotely installing and removing rotary style draw out circuit breakers without requiring any modification to the existing switchgear, allowing users to remain outside of the arc flash boundary during the potentially hazardous racking operation.

### **RSA – Remote Switch Actuator**

The CBS ArcSafe® Remote Switch Actuator (RSA) product line is made up of various application specific remote operating devices. These products allow service personnel to remotely perform all aspects of an operation for a particular type of electrical equipment from outside the arc flash boundary – reducing or eliminating the possibility of serious injury or death resulting from an arc flash.

### **RSO – Remote Switch Operator**

During a remote operation, the CBS ArcSafe® RSO functions as both the power supply and user interface for the device being remotely operated by the user. When paired with an applicable CBS ArcSafe® device, this portable standalone system allows service personnel to remotely perform a racking or switching procedure from outside the arc flash boundary – reducing or eliminating the possibility of injury or death resulting from an arc flash

Published and distributed by:  
CBS ArcSafe®  
2616 Sirius Road  
Denton, Texas 76208

A division of:  
GroupCBS, Inc.®  
P.O. Box 1557  
Gainesville, Texas 76241

Copyright CBS ArcSafe® 2015

Printed in the United States of America  
Reproduction, adaptation, or translation without prior written permission is prohibited except as is allowed by law.

# Contents

I Scope of this Technical Manual.....	v
II Alert Boxes .....	v
III Safety Information.....	vi
IV Warranty.....	vii
V CBS ArcSafe® Contact Information .....	vii
1 Standard Features and Components.....	1
1.1 RRS-1 Overview.....	1
1.2 RRS-1 Specifications.....	2
1.3 RRS-1 Components.....	4
1.4 Included Accessories.....	16
2 Preparation.....	18
2.1 Set Up Training .....	18
2.2 Unpacking the RRS-1 .....	18
2.3 Battery Charging and Care.....	21
2.4 Prior to Remote Racking Setup and Operation.....	23
3 Setup .....	26
3.1 Current Control Monitor.....	26
3.2 Drive Assembly .....	39
3.3 Torque Limiter.....	42
3.4 Control Cabinet.....	46
3.5 Tether Kit.....	50
4 Installation and Operation.....	52
4.1 Requirements for Remote Racking .....	52
4.2 Installation.....	52
4.3 Operation.....	53
5 Maintenance & Inspection .....	57
5.1 Prior to Use.....	57
5.2 After Use.....	58
5.3 Yearly Maintenance.....	58
5.4 Basic Troubleshooting Guide.....	59

# Appendices

Appendix A: Options & Accessories .....	60
Appendix B: Low Speed/Jog.....	63
B.1 Components.....	63
B.2 Operation.....	65
B.3 Setting the Jog Interval.....	66
Appendix C: Power Slide.....	68
C.1 Components.....	68
C.2 Power Slide Installation .....	69
C.3 Power Slide Operation .....	71
C.4 Power Slide Troubleshooting .....	72
Appendix D: Wireless Pendant.....	74
D.1 Wireless Pendant Station Identification.....	74
D.2 Standard Radio Remote .....	74
D.3 CCM Radio Remote .....	79
Appendix E: LED Light.....	91
E.1 Components.....	91
E.2 Operation.....	91
Appendix F: Camera System.....	92
F.1 Wireless Camera System.....	92
Appendix G: Pneumatic Tires .....	97
G.1 Components.....	97
G.2 Maintenance .....	98
Appendix H: Stair Climber Rails .....	99
H.1 Components.....	99
H.2 Application .....	100
Appendix I: Magne-blast Supervisory Link.....	101
I.1 Components .....	101
I.2 Preparation.....	105
I.3 Installation and Setup.....	111
I.4 Operation.....	118
Appendix J: Transport Assist.....	127
J.1 Components.....	127

J.2 Application.....128

Appendix K: PD Alert.....132

    K.1 Components.....132

    K.2 Application.....133

Appendix L: Notes.....134

# List of Figures

<b>Figure 1-1:</b> RRS-1 Components .....	4
<b>Figure 1-2:</b> Height Adjustment Handle .....	5
<b>Figure 1-3:</b> Storage Bag.....	6
<b>Figure 1-4:</b> Drive Motor Gearbox.....	6
<b>Figure 1-5:</b> Drive Motor.....	7
<b>Figure 1-6:</b> Floor Locks.....	7
<b>Figure 1-7:</b> Height Adjustment Rail Assembly (Shown rotated at 90°) .....	8
<b>Figure 1-8:</b> Drive Motor Brake.....	8
<b>Figure 1-9:</b> Torque Limiter Assembly .....	9
<b>Figure 1-10:</b> Spring Loaded Drive Head .....	9
<b>Figure 1-11:</b> Rear Wheels.....	10
<b>Figure 1-12:</b> Front Wheels.....	10
<b>Figure 1-13:</b> Main Power Disconnect .....	11
<b>Figure 1-14:</b> Power Cord Receptacle .....	11
<b>Figure 1-15:</b> Power Supply.....	12
<b>Figure 1-16:</b> Wired Pendant Station .....	12
<b>Figure 1-17:</b> Wired Pendant Coil Cord .....	13
<b>Figure 1-18:</b> Current Control Monitor .....	14
<b>Figure 1-19:</b> Control Cabinet.....	14
<b>Figure 1-20:</b> CCM Status Indicator Light .....	15
<b>Figure 1-21:</b> CCM Status Indicator Siren.....	15
<b>Figure 1-22:</b> Power Cord (North American standard shown).....	16
<b>Figure 1-23:</b> Dust Cover .....	16
<b>Figure 1-24:</b> Tether Kit Components .....	17
<b>Figure 1-25:</b> Torque Limiter Wrench .....	17
<b>Figure 2-1:</b> RRS-1 palletized and awaiting shipment.....	20
<b>Figure 2-2:</b> Low Battery Alert on CCM.....	21
<b>Figure 3-1:</b> CBS ArcSafe® CCM.....	26
<b>Figure 3-2:</b> CBS ArcSafe® Legacy CCM.....	27
<b>Figure 3-3:</b> CBS ArcSafe® CCM configuration .....	28
<b>Figure 3-4:</b> CBS ArcSafe® Legacy CCM configuration.....	29
<b>Figure 3-5:</b> CCM Status Indicator indicating light .....	34
<b>Figure 3-6:</b> CCM Status Indicator audible alarm .....	34
<b>Figure 3-7:</b> How to Determine if Hand Crank is Installed .....	39
<b>Figure 3-8:</b> Drive Assembly Mount Fasteners.....	40
<b>Figure 3-9:</b> Torque wrench and torque limiter adjustment wrench.....	44
<b>Figure 3-10:</b> Torque limiter assembly schematic .....	45
<b>Figure 3-11:</b> RRS-1 Control cabinet.....	46
<b>Figure 3-12:</b> Control Cabinet Components.....	47
<b>Figure 3-13:</b> Tether kit components .....	50

# About the User's Guide

Congratulations on the purchase of a new CBS ArcSafe® RRS-1 unit! This manual contains information for users which details the preparation, setup, and operation of the RRS-1. In addition, there are descriptions of many of the important components that make up the unit as well as basic troubleshooting information. This manual is intended to be the user's first point of reference when using the RRS-1, and therefore is full of useful information which is intended to help all users, ranging from the novice first time users to the most experienced ones.

## *I Scope of this Technical Manual*

This technical manual describes the features and functions of the CBS ArcSafe® RRS-1. This document is intended to act as a reference for users of the RRS-1 allowing for safe, quick, and efficient use of the RRS-1 features.

### **ATTENTION!**

All users of this product must read and follow any and all instructions or information provided within this manual. If after carefully reading this document in its entirety there are any questions or concerns regarding its content, or if any further information is required, please contact CBS ArcSafe®. Users are required read and understand this document before installing or operating this equipment.

## *II Alert Boxes*

Throughout this manual there are highlighted areas of information that are extremely important for users to follow when working with the RRS-1. Critically important information regarding safe operation of the RRS-1 will be highlighted in this document in the two following manners.

### **II.A Danger Alert**

Danger alerts will be housed in red text boxes as shown below. These danger alerts contain information pointing out potential hazards to personnel and equipment. All users of this product must read and follow the information given within these warnings. If any questions or concerns exist after reading all applicable information provided within this document please contact CBS ArcSafe® for more information.

### **DANGER!**

This is an example of a red danger alert box. These danger alerts contain information pointing out potential hazards to personnel and equipment.

### **II.B Attention Alert**

Attention alerts will be housed in green text boxes as shown below. These attention alerts contain important information regarding use of the RRS-1. All users of this product must read and follow the information given within these warnings. If any questions or concerns exist after reading all applicable information provided within this document please contact CBS ArcSafe® for more information.

## ATTENTION!

This is an example of a green attention alert warning box. These attention alert warnings contain important information regarding use of the RRS-1.

## II.C Note Alert

Note alerts will be housed in gray text boxes as shown below. These note alerts contain special or conditional information regarding the use of the RRS-1.

### NOTE:

This is an example of a gray note alert box. These note alerts contain special information regarding the RRS-1.

## III Safety Information

Prior to operating the RRS-1 please read and understand the following safety information.

### DANGER!

Ensure that any and all personnel using this equipment are trained in the safe operation of the electrical equipment to be operated. Users are to remain stationed outside of the arc flash boundary while operating this equipment and must comply with all applicable federal, state, local, and in-house safety regulations and procedures. Users must also consider distance and angle with respect to the location of the operation, as well as proper personal protective equipment (PPE).

### DANGER!

Any and all users of the CBS ArcSafe® RRS-1 must read this manual and adhere to all information and instructions provided within before installing or operating the RRS-1. If after carefully reading the manual in its entirety questions or concerns still persist, please contact CBS ArcSafe® for more information regarding these or any issues.

### DANGER!

Ensure that all equipment to be remotely operated is properly maintained and in adequate working order prior to using the RRS-1. If users are unsure about the condition of the electrical equipment to be remotely operated, please contact a local Group CBS service provider at [www.gcbs.com](http://www.gcbs.com) to assist in proper care and maintenance of damaged or faulty circuit breaker equipment.

### DANGER!

Any operation, modification, or maintenance of this product not in accordance with this document could result in death, serious personal injury, or property damage. Any further operation, modification, or maintenance beyond the scope of what is contained in this manual must be performed by trained CBS ArcSafe® personnel familiar with the equipment and the risks associated with arc flash. At the discretion of CBS ArcSafe, any violation of these terms may void any and all warranties, written or implied.



## **IV Warranty**

CBS ArcSafe® products are guaranteed to be free of defects in materials and workmanship for one year from the date of shipment. This warranty does not cover damage caused by accident, improper care, negligence, normal wear and tear, natural causes, unlicensed repairs, and incompetent supervision. This warranty also does not cover repairs or replacements made by unauthorized individuals except when agreed to in writing. Damage not covered under warranty will be repaired for a reasonable rate and a fee will be charged for return shipping.

## **V CBS ArcSafe® Contact Information**

For more information, questions, or comments about the RRS-1, this manual, or any other CBS ArcSafe® product, please feel free to contact us:



# 1 Standard Features and Components

This section will educate users on the components and features found on all RRS-1 units. For users who have purchased additional options, please see the corresponding appendices describing these options.

## 1.1 RRS-1 Overview

The CBS ArcSafe® RRS-1 is a portable, easily adjustable, and user friendly remote racking system designed for safe and reliable operation when installing or removing rotary style circuit breakers. The main objective behind the unique design and simple operation of the RRS-1 remote racking system is to station the operator safely outside of the arc flash boundary while the RRS-1 performs the potentially dangerous racking procedure. When set up and operated correctly, the RRS-1 is an invaluable tool in keeping personnel safe from the hazards of arc flash and its lethal consequences.

The RRS-1 is operated using the wired pendant station, which serves as the operational user interface, via a 35' coil cord (additional cord lengths or an optional radio remote pendant station are available). The wired pendant station communicates the user's request to the control cabinet which houses RRS-1 controls. This operational command is then sent from the control cabinet to drive assembly, beginning the racking procedure. During the racking procedure the RRS-1 is continually monitoring certain machine parameters and comparing them to user input settings. When equipped with the proper tooling and properly setup, the RRS-1 is able to rack any rotary style breaker in or out and automatically cease operation once the racking procedure has been completed.



## 1.2 RRS-1 Specifications

This section will detail the physical, mechanical, and electrical specifications of the RRS-1. This section will cover only the basic specifications of the RRS-1 that are critical for safe and educated use. For more detailed specifications of the RRS-1 please contact CBS ArcSafe®.

### 1.2.1 RRS-1 General Specifications

The following table contains relevant specifications relating to the RRS-1.

#### RRS-1 General Specifications

<b>Weight</b>	...	200 lbs
<b>Battery Life</b>	...	>50 Operations*
<b>System Voltage</b>	...	24 VDC
<b>Input Voltage</b>	...	120±10% VAC, 47-63 Hz†
<b>Maximum AC Current</b>	...	12.2 A
<b>Drive Motor Power</b>	...	250 W
<b>Drive Assembly Speed</b>	...	80 RPM
<b>Charge Time</b>	...	Approximately 3 hours
<b>Dimensions</b>	...	74"H x 26"W x 38.1"D
<b>Operating Distance</b>	...	35 Ft‡

\* Number of operations is dependent on the nature of the operation

† May be custom ordered to match different local power standards

‡ Standard configuration, contact CBS ArcSafe® for other options

### 1.2.2 RRS-1 Wiring Diagram

Wiring diagrams for customers' RRS-1 units are available from CBS ArcSafe® upon request. Due to the complexity and number of unique schematics associated with each different RRS-1 produced, these documents will not be provided in this manual. Contact CBS ArcSafe® for more information about this policy.

### 1.2.3 RRS-1 Dimensions

The following image details the working dimensions of the RRS-1. Dimensions are in inches unless otherwise noted and are for reference only.

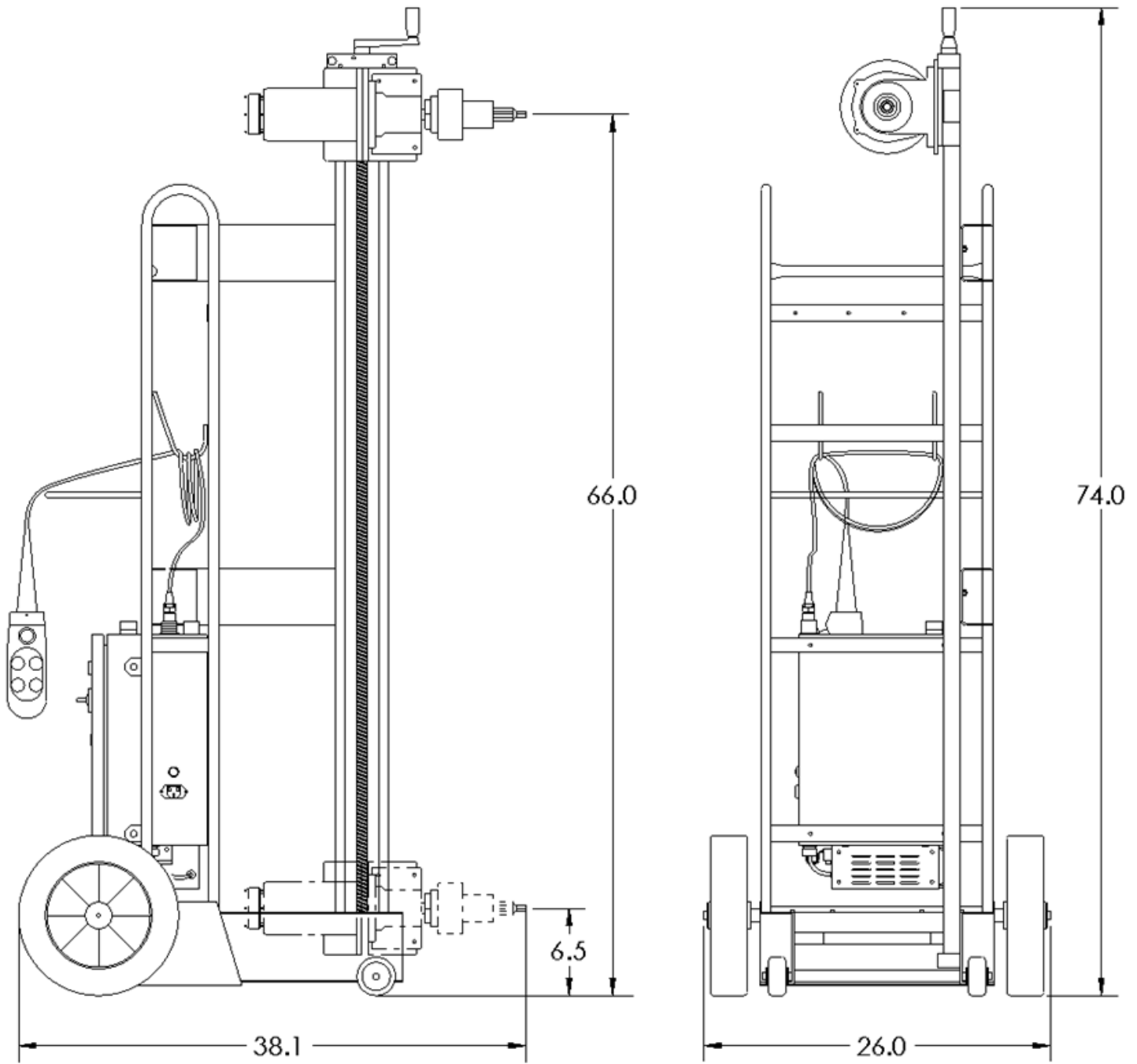

### 1.3 RRS-1 Components

This section will highlight the various mechanical and electrical components of the RRS-1 with which users must be familiar in order to operate the unit. This section will only discuss the components which are pertinent to the preparation, setup, or operation of the RRS-1 and will not include those that are not necessary for these procedures. RRS-1 components which do not fall under the scope of this section will be omitted. If for any reason users would like more information about any of the components found on the RRS-1 please contact CBS ArcSafe®.

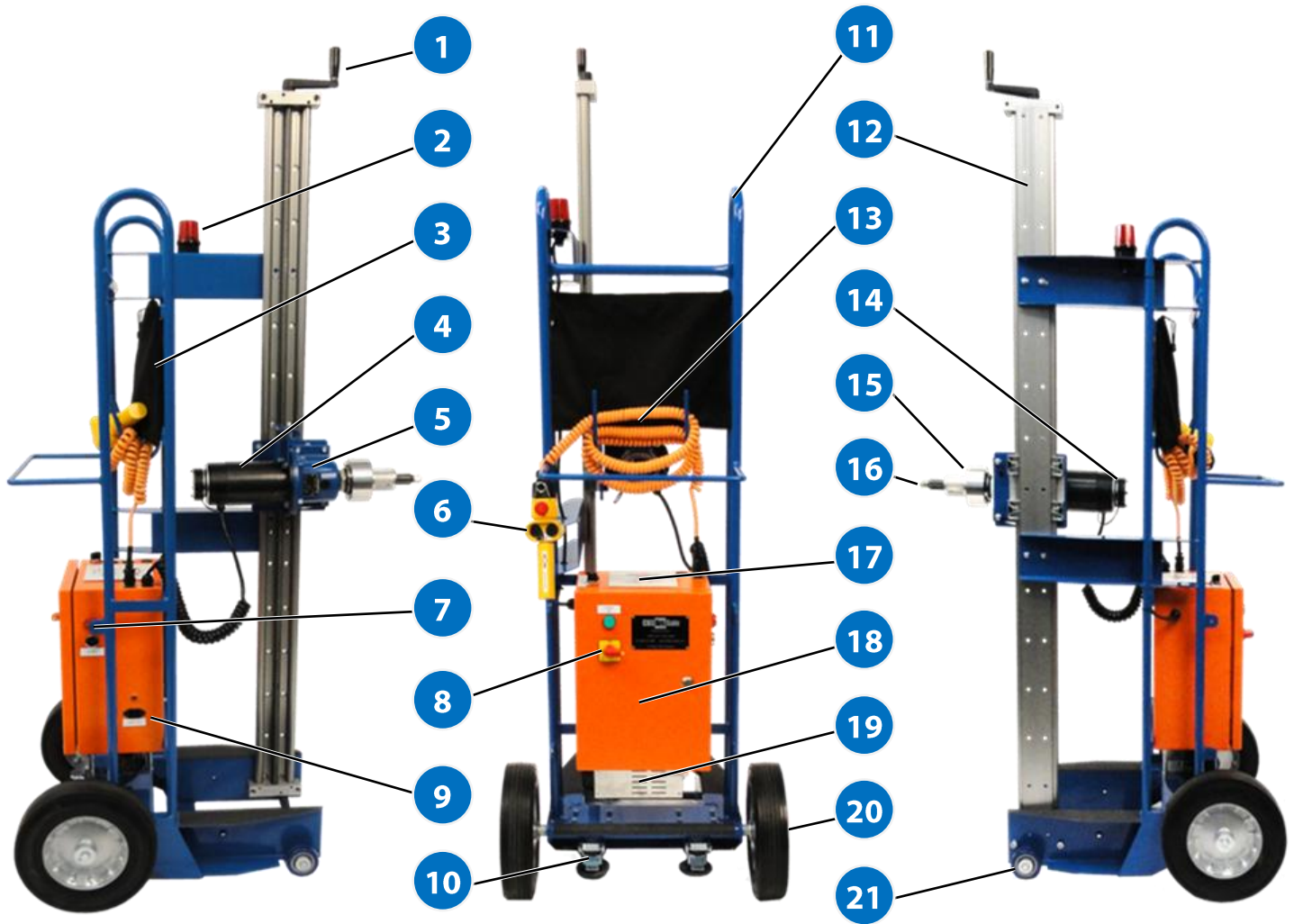

- |                               |                              |                              |
|-------------------------------|------------------------------|------------------------------|
| 1. Height Adjustment Handle   | 8. Main Power Disconnect     | 15. Torque Limiter Assy.     |
| 2. CCM Status Indicator Light | 9. AC Power Input Receptacle | 16. Spring Loaded Drive Head |
| 3. Storage Bag                | 10. Floor Lock               | 17. Current Control Module   |
| 4. Drive Motor                | 11. Frame                    | 18. Control Cabinet          |
| 5. Drive Motor Gearbox        | 12. Slide Rail               | 19. Power Supply             |
| 6. Wired Pendant Station      | 13. Wired Pendant Coil Cord  | 20. Rear Wheels              |
| 7. CCM Status Indicator Siren | 14. Drive Motor Brake        | 21. Front Wheels             |

Figure 1-1: RRS-1 Components

### 1.3.1 Mechanical Components

The key mechanical components of the RRS-1 will be highlighted in this section. Please see the following list for a detailed description for each mechanical component shown in Figure 1-1.

1. **Height Adjustment Handle ( Figure 1-2 )** – The height adjustment handle is used to manually raise and lower the drive assembly in order to rack circuit breakers with racking mechanisms of varying heights. Users turn the handle clockwise to raise the drive assembly or counterclockwise to lower it. When the RRS-1 shipment arrives, the plastic portion of the handle will be located within the storage bag and must be reassembled prior to use.



**Figure 1-2:** Height Adjustment Handle

#### ATTENTION!

Take precaution not to damage the height adjustment handle as it is the highest point on the RRS-1. Users should take extra cautionary measures when transporting the RRS-1 through doorways or other low clearance environments to ensure that the height adjustment handle does not interfere with the surroundings and become damaged.

2. **Storage Bag ( Figure 1-3 )** – The storage bag is located on the upper portion of the RRS-1 and is secured to the frame via steel rivets. The storage bag useful for storing accessories required for use during remote racking operations (Including but not limited to tooling, tether kit, additional cords or cables, manuals, etc). When the RRS-1 shipment arrives there may be several additional items located within the storage bag depending on the RRS-1 configuration. Please remove and inventory all items from within the storage bag in order to make sure that each has arrived and can be accounted for. It is recommended to leave the storage bag zipped closed when not in use in order to keep the bag from “sagging” under the weight of its contents in addition to keeping foreign matter out. The following figure shows the storage bag mounted to the RRS-1.



**Figure 1-3:** Storage Bag

3. **Drive Motor Gearbox ( Figure 1-4 )** – The drive motor gearbox is the large cast iron housing attached to the front side of the drive motor. The gearbox takes the incoming rotary motion from the drive motor and slows it down to a point where the output speed is similar to human operator racking a breaker by hand. By doing so, the torque is increased to a point where the RRS-1 is capable of racking even the largest breakers. The following image details the drive motor gearbox.



**Figure 1-4:** Drive Motor Gearbox

4. **Drive Motor ( Figure 1-5 )** – The drive motor provides the rotary motion used in circuit breaker racking operations and is controlled by the user's commands during these operations. Rotary motion is transferred through the drive motor gearbox and into the torque limiter assembly where it is output (At a higher torque and lower RPM) to the spring loaded drive head in order to perform the racking operations. The drive motor is a very robust and heavy duty brushed DC motor capable of years of service without issue. Figure 1-5 highlights the drive motor found on the drive assembly.



**Figure 1-5:** Drive Motor

5. **Floor Locks ( Figure 1-6 )** – Each RRS-1 is equipped with a pair of floor locks or machine stabilizers. Engaging the pair of floor locks slightly lifts the rear wheels off the ground to prevent RRS-1 movement during a racking operation (Not all breakers will require the use of the floor locks during racking operations). Push down on the protruding lever to engage the floor locks; to disengage the floor locks push up on the protruding lever. The drive assembly stays nearly level due to the fact that the floor locks lift the unit off of the ground only approximately 1/8" when properly adjusted (Floor locks are recommended to be used only on level ground, otherwise the unit may become tilted in one direction when they are engaged). Figure 1-6 shows the floor locks mounted to the lower portion of the RRS-1.

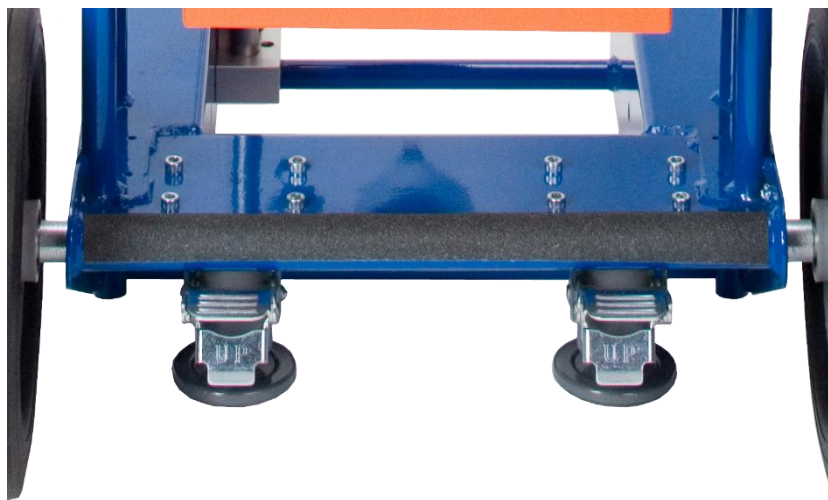

**Figure 1-6:** Floor Locks

6. **Frame** – All components of the RRS-1 are directly or indirectly mounted to and supported by the steel frame. The curved top tubes act as handles when tilting the unit on the rear wheels for transportation. The hand truck style design provides users with easy mobility when transporting the unit and rigid stability during racking operations. Integrated storage hooks are provided to secure the pendant station and wired pendant coil cord when not in use.



- 7. Height Adjustment Rail Assembly ( Figure 1-7 )** – The height adjustment rail assembly is a heavy duty extruded aluminum track system which allows the drive assembly to be raised or lowered seamlessly. The height adjustment rail assembly consists of the extruded aluminum rail, the carriage which mounts to the drive assembly and shuttles it up and down, and the height adjustment rail screw which provides the means to raise or lower the carriage via the height adjustment handle.



**Figure 1-7:** Height Adjustment Rail Assembly (Shown rotated at 90°)

- 8. Drive Motor Brake ( Figure 1-8 )** – The RRS-1 drive motor is equipped with an electromagnetic brake which prohibits any rotary motion of the drive assembly when it is engaged. (NOTE: The brake is engaged or “ON” when power to the brake has been removed and the brake is disengaged or “OFF” when power is supplied to the brake. It is for this reason that the brake will be engaged or “ON” when the RRS-1 is powered off). When the brake control switch is in the “ON” position, the brake will automatically engage itself when the signal is given to stop the motor, thus limiting any over travel of the motor. In order to rotate the drive assembly by hand, the main power must be “ON” and the brake control switch must be “OFF”.



**Figure 1-8:** Drive Motor Brake

9. **Torque Limiter Assembly ( Figure 1-9 )** – The torque limiter assembly couples the rotary motion from the drive motor gearbox to the spring loaded drive head. The torque limiter assembly provides a level of over-torque protection to the remote racking operation by utilizing a mechanically adjustable slip clutch. Users can set the torque limiter to any value within a range of torque values, which prevents the RRS-1 from transferring any torque above the set amount into the breaker racking mechanism no matter what current settings are input into the CCM.



**Figure 1-9:** Torque Limiter Assembly

10. **Spring Loaded Drive Head ( Figure 1-10 )** – All RRS-1 rotary tooling will attach to the unit via the spring loaded drive head. The ½" square drive head utilizes a locking ball coupler to keep the tooling connected to the drive head until the operator manually releases it. The spring loaded backing of the drive head allows it to absorb any unnecessary force of otherwise rigid movements during racking operations or when mating the tooling to the breaker racking mechanism.



**Figure 1-10:** Spring Loaded Drive Head

11. **Rear Wheels ( Figure 1-11 )** – The rear wheels allow user to tilt the RRS-1 back similar to a hand truck or dolly for transportation. These solid rubber steel rimmed wheels are extremely durable and are designed for use in very harsh environments. Being made of solid rubber, users will never have to worry about a flat or inflating these tires before use.



**Figure 1-11:** Rear Wheels

12. **Front Wheels ( Figure 1-12 )** – The front wheels create a secure, steady, and level platform during operation and storage. These solid wheels are fixed to the front axle of the RRS-1 for the purpose of aligning the RRS-1 to the circuit breaker racking mechanism prior to a racking operation.



**Figure 1-12:** Front Wheels

### 1.3.2 Electrical Components

The key electrical components of the RRS-1 will be highlighted in this section. Please see the following list for a detailed description for each electrical component shown in Figure 1-1.

1. **Main Power Disconnect ( Figure 1-13 )** – The main power disconnect is located on the left side of the control cabinet (Or on the backside on older units such as the one shown in Figure 1-1). Near the main power disconnect there will be a green light labeled “POWER ON”. When the main power disconnect is in the “ON” position the “POWER ON” light should be illuminated green. This disconnect controls the power for the entire RRS-1.



Figure 1-13: Main Power Disconnect

2. **AC Power Input Receptacle ( Figure 1-14 )** – The AC power input receptacle is located near the bottom of the control cabinet on the right side. In order to charge the batteries or run the RRS-1 using AC power, users will have to ensure the main disconnect is in the “OFF” position before plugging the supplied power cable into this receptacle. The red light above the receptacle will illuminate when AC voltage is present. Power standards vary across the globe and the label identifying acceptable input power will match standards for its destination.



Figure 1-14: Power Cord Receptacle

3. **Power Supply ( Figure 1-15 )** – The RRS-1 power supply provides both the battery charging capabilities and the AC operation capabilities to the unit. When plugged into AC power, the power supply will work to charge the batteries unless called upon to provide additional power to operate the machine in the event that the battery charge is not sufficient to operate it. Power standards vary across the globe and the power supply included with the RRS-1 will match standards for its destination.



**Figure 1-15:** Power Supply

4. **Wired Pendant Station ( Figure 1-16 )** – The wired pendant station controls the operation of the drive assembly remotely. The RRS-1 comes standard with a two button wired pendant station which allows the operator to perform Install and Remove operations remotely. The wired pendant station is connected to the RRS-1 by means of the wired pendant coil cord which attaches to the RRS-1 on the top side of the control cabinet via a threaded receptacle. Onboard storage of the wired pendant station and wired pendant coil cord is provided via the frame storage hooks or the storage bag.



**Figure 1-16:** Wired Pendant Station

- **Install Pushbutton ( Figure 1-16.1 )** – When this button is pressed, the RRS-1 begins an Install operation in the mode specified by the current CCM setup. This can either be an automatic operation (CCM “Install” setpoint at any value greater than 0.0) or a manual operation (CCM “Install” setpoint at 0.0).
  - **Remove Pushbutton ( Figure 1-16.2 )** – When this button is pressed, the RRS-1 begins a remove operation in the mode specified by the current CCM setup. This can either be an automatic operation (CCM “Remove” setpoint at any value greater than 0.0) or a manual operation (CCM “Remove” setpoint at 0.0).
  - **Emergency Stop Pushbutton ( Figure 1-16.3 )** – When this button is pressed, the unit will shut down and all systems will lose power. Pressing this button will cease any operation being performed at the time it is depressed. To resume normal operation, reset the Emergency Stop by rotating the button clockwise until it springs back outward and allow the unit several seconds to power back on.
5. **Wired Pendant Coil Cord ( Figure 1-17 )** – The wired pendant coil cord allows the operator of the RRS-1 to distance themselves from the breaker during the install and remove operations. The coil cord connects the wired pendant station to the control cabinet via a threaded receptacle located on the top side of the control cabinet. The threaded connection allows for quick and simple removal of the cord and pendant for storage or to add a cord extension.



**Figure 1-17:** Wired Pendant Coil Cord

**DANGER!**

In some circumstances the wired pendant coil cord may not provide enough distance for service personnel to completely exit the arc flash boundary during operation of the RRS-1. CBS ArcSafe® offers wired pendant coil cord extensions, two radio remote options, and wired or wireless video systems for remote operation at extended distances. Attention should always be given to distance, angle, and personal protective equipment (PPE) when using the RRS-1.

6. **Current Control Monitor ( Figure 1-18 )** –The Current Control Monitor (CCM) serves as the brains of the RRS-1 during remote racking operations as well as the user interface for changing any settings. For more information about the CCM, its setup and functionality, as well as its user interface and button layout, please see Section 3.1.



**Figure 1-18:** Current Control Monitor

7. **Control Cabinet ( Figure 1-19 )** – The control cabinet houses all of the electronics vital for RRS-1 operation. This enclosure is designed to protect these sensitive electronic components from foreign material such as dust, dirt, oil, and water. In addition to housing and protecting all internal electronics, the control cabinet also houses user interface controls such as the CCM, main power switch, and various other switches depending on which options are installed on the machine.



**Figure 1-19:** Control Cabinet

8. **CCM Status Indicator Light ( Figure 1-20 )** – The CCM Status Indicator Light remains on steadily when the drive motor is running and begins to flash when the RRS-1 signals the motor to stop. This signifies that racking is complete when the CCM and clutch are properly set up for the breaker being racked.



**Figure 1-20:** CCM Status Indicator Light

9. **CCM Status Indicator Siren ( Figure 1-21 )** – The CCM status indicator siren sounds loudly when a racking operation is complete. The volume of the siren may be adjusted by rotating the siren's exterior housing and exposing or covering the sounding element.



**Figure 1-21:** CCM Status Indicator Siren



## 1.4 Included Accessories

This section will cover the standard accessories included with each RRS-1 purchased.

1. **Power Cord ( Figure 1-22 )** – The power cord is included with the RRS-1 and can be found in the storage bag upon RRS-1 delivery. Power cord standards vary across the globe and the power cord included with the RRS-1 will match standards for its destination. The power cord can be plugged into the power cord receptacle and is used for charging the batteries or running the unit off of AC power.



**Figure 1-22:** Power Cord (North American standard shown)

2. **Dust Cover (Figure 1-23)** – Each RRS-1 is shipped with an included dust cover. The dust cover is supplied to help customers keep the RRS-1 as clean as possible when not in use. CBS ArcSafe® recommends that the dust cover be kept on the machine when not in use, especially in extremely dirty environments. Keeping the RRS-1 clean will increase the unit's longevity.



**Figure 1-23:** Dust Cover

3. **Tether Kit (Figure 1-24)** – Another accessory shipped with each RRS-1 is a tether kit. The tether kit allows user to tether the RRS-1 to the breaker being racked. This is especially important for breakers with moving racking mechanisms. For instructions on tether kit setup please see Section 3.5



**Figure 1-24:** Tether Kit Components

4. **Torque Limiter Wrench (Figure 1-25)** – The torque limiter wrench is included with the RRS-1 and can be found in the storage bag upon arrival. This wrench fits over the torque limiter's adjustment nut and allows users to set the maximum amount of torque output by the RRS-1. See Section 3.3.2.2 Setting the Torque Limiter for information detailing how to set the torque limiter.

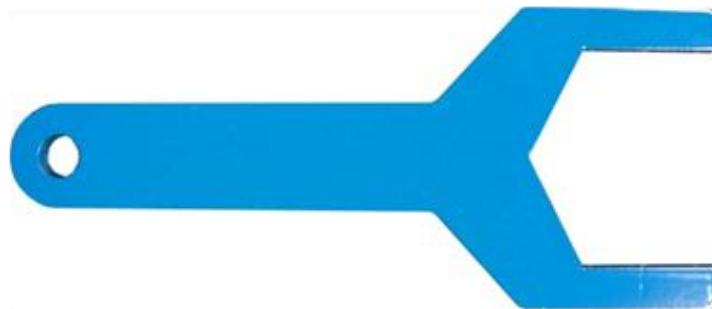

**Figure 1-25:** Torque Limiter Wrench

5. **Entitlement Tool** – The RRS-1 remote racking system is able to operate with many different styles of tools for many different styles of breakers. Each RRS-1 purchased comes with an "entitlement tool" included in the price. In order to purchase additional tooling for additional styles of breakers please contact CBS ArcSafe®.

## 2 Preparation

This section will describe all of the necessary steps that must be taken prior to setting up and operating the RRS-1. Whether the RRS-1 is being operated by a brand new, first time user or an experienced technician, following these steps will help to ensure proper RRS-1 operation when it comes time to rack the breaker remotely.

### 2.1 Set Up Training

Included in the purchase price of the RRS-1 is four hours of on-site training from either a CBS ArcSafe® equipment representative or an approved CBS ArcSafe® outside representative. Please contact CBS ArcSafe® to set up this training seminar for any service personnel who will be using the equipment prior to operation.

#### **DANGER!**

It is very important that any personnel operating this equipment have proper training before any and all use. Improper use due to lack of training may damage the RRS-1 or the switchgear. Operation prior to training may also void all warranties, written or implied. Do not operate the RRS-1 until training has been received.

Additional training may be purchased at the time of machine purchase or at a later date. Please contact CBS ArcSafe® for more details about purchasing extra onsite training.

### 2.2 Unpacking the RRS-1

Unpacking the RRS-1 correctly is very important; careless or violent unpacking methods can potentially damage the RRS-1 and/or any other packages that may be included in the shipment. Please exercise caution when unpacking the RRS-1 from its shipping container.

The RRS-1 unit will arrive onsite via freight - please take caution when loading or unloading the shipping container to ensure that the contents inside will not be damaged. The shipping container consists of a pallet, the shipping box which is mounted to the pallet, and a box lid. The RRS-1 unit will be banded to the pallet to ensure that it remains in place in the shipping container during shipment. The RRS-1 unit will also be wrapped in shrink wrap to protect it from any damage should the shipping container be compromised. The following steps will instruct the user in the proper method for unpacking the RRS-1.

1. First, remove the lid from the shipping box. To remove the lid, cut all tape and shrink wrap which secure it to the shipping box. Lift the lid off.
2. Next, remove the shipping box by either by cutting along the base perimeter with a utility knife or by removing the nails/screws securing the shipping box to the pallet.

#### **ATTENTION!**

Prior to discarding the shipping box, ensure that all necessary paperwork fixed to the exterior of the box, including the packing list, is removed and set aside.

3. Next, either cut vertically along an edge of the box to expose the contents, or carefully lift the box over the RRS-1 and set aside. Ensure that any additional packages within the shipment do not fall out when removing the box as their location may have shifted during shipping.
4. Set aside any and all additional packages surrounding the RRS-1 on the pallet until only the RRS-1 remains on the pallet.
5. With tin snips or a similar tool, carefully cut and remove the steel straps securing the RRS-1 to the pallet. Carefully roll the unit off of the pallet and onto the floor.

### **DANGER!**

The steel straps securing the RRS-1 to the pallet are under very high tension. When cutting the straps they may spring outward once they have been cut through. Please wear safety glasses and do not stand directly over the straps when cutting.

6. Depending on the options installed on the RRS-1, some minor assembly may be required. Please do not attempt to assemble these components. They will be assembled by a CBS ArcSafe® representative prior to training.
7. Unpack any and all additional packages that arrived with the RRS-1. Using the packing list, inventory all items to ensure everything has arrived. Also check for any noticeable damage that may have occurred during shipping. If any shipping damage is found, immediately document the damage and contact CBS ArcSafe®.
8. Lastly, store all equipment together in one location until training.

### **ATTENTION!**

Prior to training, a CBS ArcSafe® representative will again inventory all equipment and ensure everything that is needed for operation is present

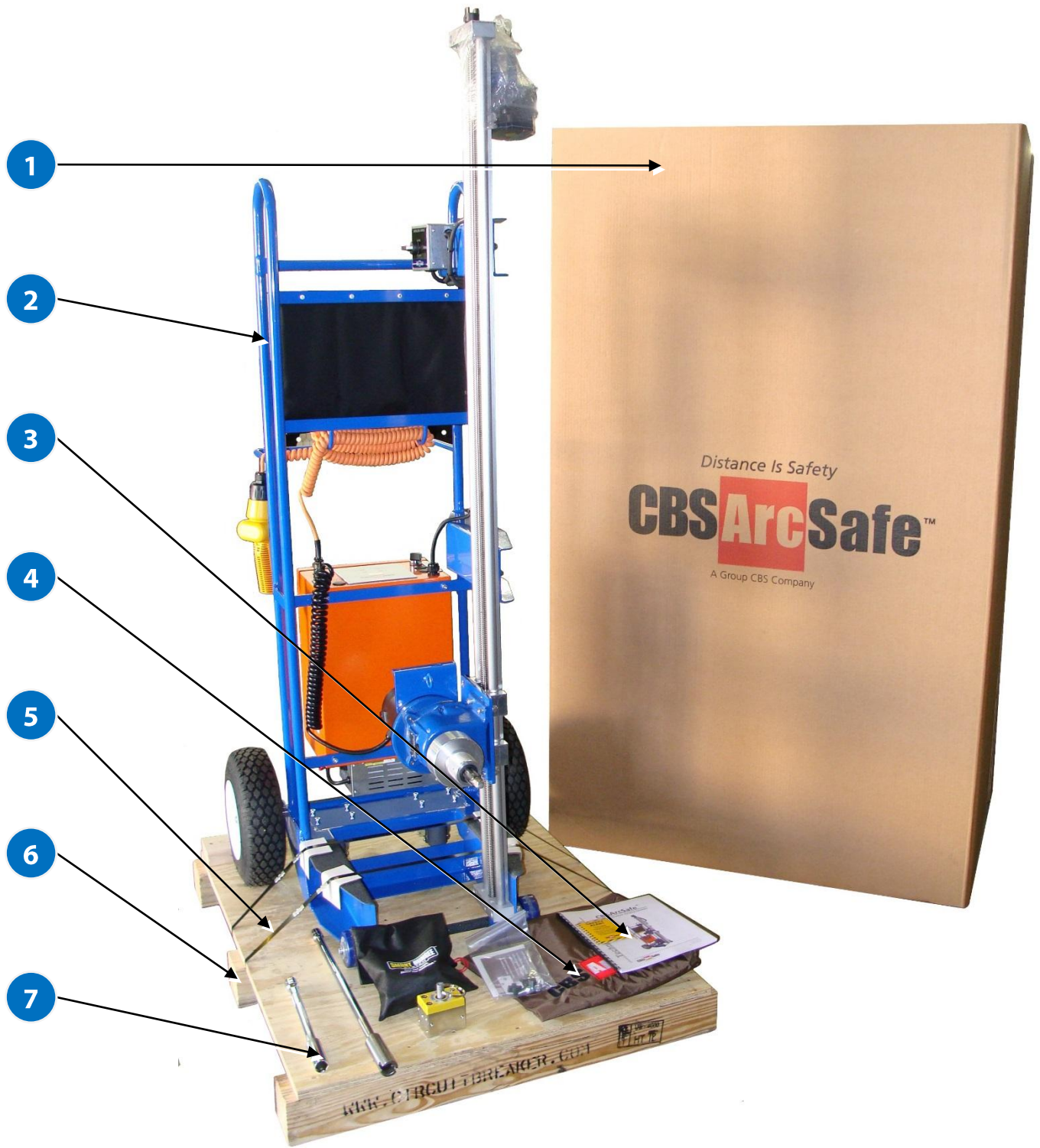

- 1. Shipping Box
- 2. RRS-1 Unit
- 3. Technical Manual

- 4. Dust Cover
- 5. Steel Straps
- 6. Pallet

- 7. Tooling

**Figure 2-1:** RRS-1 palletized and awaiting shipment

## 2.3 Battery Charging and Care

The CBS ArcSafe® RRS-1 unit is equipped with a smart AC/DC power system which can utilize either the internal batteries or an AC power source to run the unit. Proper battery charging and maintenance will prolong the life of the batteries within the RRS-1. This section will describe the proper steps to charge the RRS-1 as well as give guidelines on how to prolong battery life.

### 2.3.1 Charging the Batteries

The internal batteries enable users to operate the RRS-1 when AC power is unavailable, and will take over if AC power is lost during a racking operation, allowing the RRS-1 to continue the operation uninterrupted. The AC power supply serves as both the main power system and battery charger when plugged into AC power. The power supply runs on AC utility power and will power the RRS-1 unit during remote racking operations when it is plugged in. If the unit remains plugged in after the racking operation has been completed and the machine has been shut off, the power supply will work to charge the internal batteries. Perform the following steps to charge and store the unit to prepare for future operation:

1. Prior to charging, power on the unit and read the CCM display. After the initial power up (Where the display will read "vX.X" where X.X is the current version of firmware loaded into the CCM) the display should read "0.0" to signal to the user that the unit is ready for operation. If the display reads "- bA" as shown in Figure 2-2, then the unit has a low battery (<18 VDC) and must be charged prior to operation.



Figure 2-2: Low Battery Alert on CCM

2. If, during a racking operation, the unit's system voltage drops below the minimum voltage necessary for operation, the unit will complete the racking operation being performed, but the CCM will lock out further operation until the batteries have been charged and the power has been cycled.
3. To charge the unit from a low battery state, first ensure that the unit is powered off by turning the main disconnect switch on the side of the control cabinet to the "OFF" position.
4. Remove the RRS-1 power cord from the storage bag and insert the corresponding end into the power connector located on the control cabinet. Next, plug the opposite end of the power cord into a grounded electrical outlet, supplying the required power for the RRS-1 as specified on the label beneath the power connector.

### ATTENTION!

Depending on the date of manufacture or the options/upgrades installed on the RRS-1, the power connector may be located on the side of the control cabinet (post 2009) or the bottom (pre 2009).

5. The red light located above the power connector should illuminate when AC power is applied, indicating that the machine is charging. If the red light does not illuminate, check to make sure that the incoming AC power source is functioning properly. If the AC power source is not functioning properly, contact CBS ArcSafe® for troubleshooting tips.

### NOTE:

For units which have the power charger receptacle on the bottom, the red light above the power connector may not be present. Instead there should be an LED light on the charger to indicate that it is currently charging.

6. Whenever possible, leave the CBS ArcSafe® RRS-1 plugged in when not in use. Leaving the unit plugged in and properly stored with either the provided dust cover or the water resistant cover (Optional) will ensure that the RRS-1 is protected and ready for the next operation. Once the batteries have reached full capacity, the battery charger switches to a "standby voltage mode" maintaining a fully charged battery.

### NOTE:

If the unit's batteries are completely dead it will take approximately 3 hours to charge before the unit will be able to be used properly (System voltage must be at least 18 VDC or higher for the unit to operate properly and may be checked with a multimeter).

## 2.3.2 Battery Care Best Practices

The batteries within the RRS-1 provide backup power to the unit should AC power not be available during the remote racking operation. However, if the batteries are not maintained properly they will lose their charge capacity and be ineffective when the time comes to utilize them. Please follow these guidelines when operating the RRS-1 on battery power or charging the batteries. Following these guidelines will guarantee that users will get the most life out of their batteries.

- *DO NOT FULLY DISCHARGE THE BATTERIES.* This will severely shorten the service life of the batteries. A common myth surrounding lead-acid batteries is that they must be fully discharged prior to being charged – this is NOT the case.
- *Exercise the batteries regularly.* Run the unit on battery power at minimum once a month to keep the batteries in functional condition.
- *Charge the batteries as soon as possible after use.* Charging the batteries immediately after use will reduce effect of sulfation on the batteries and increase their useful life.
- *Only use the charger/power supply supplied with the RRS-1 to charge the batteries.* This charger is equipped with a monitor that allows it to provide the optimum charging voltage based on the battery's current state.
- *Do not allow the batteries remain discharged for long periods of time.* Ensure that they are charged regularly to full capacity.
- *Only store the unit in locations that will be kept at moderate temperatures.* Extreme cold or heat may reduce the service life of the batteries.

### **DANGER!**

Storing the RRS-1 extreme temperatures will drastically reduce battery performance and life. CBS ArcSafe® recommends storing the unit in a temperature controlled environment when available.

- If operation must occur in locations with extreme temperatures, plug the unit into AC power during operation to reduce the strain on the batteries.

### **ATTENTION!**

At extreme temperatures battery performance will be reduced below its normal level. CBS ArcSafe® recommends that the unit only be operated when plugged into AC power in these environments to prolong battery life and ensure proper RRS-1 performance.

## **2.4 Prior to Remote Racking Setup and Operation**

Prior to beginning any remote racking procedure, CBS ArcSafe® recommends that users inspect the RRS-1 for both mechanical and electrical integrity, as well as inspect the location in which the operation will occur. Improper operation, storage, or transport prior to usage may affect the operational ability of RRS-1. This section will describe in detail the necessary preparation of the RRS-1 and surrounding environment prior to beginning any remote racking operation.

### **2.4.1 RRS-1 Inspection**

Prior to using the RRS-1 for a remote racking operation, please ensure that the following items have been addressed (Parts of the following list are also available in Section 5.1 detailing regular maintenance and inspection of the RRS-1):



- *Ensure that the applicable tooling for the selected breaker is available and in good working order.* In the event that the user will be operating the RRS-1 using specialized or non-standard tooling, please see the specific manual received with the tooling. If the manual accompanying the tooling is not able to be found, please contact CBS ArcSafe® for a replacement hard copy or electronic copy
- *Inspect all plugs, receptacles, and cord grips for any damage.* To ensure proper connection is made, tighten connections where necessary.
- *Inspect all cables for wear or damage.* Make arrangements to replace any damaged or frayed cables immediately by contacting CBS ArcSafe®.
- *Check for any loose or missing hardware.* Retighten or replace hardware as necessary.
- *Power up and run the unit to ensure all functions are working properly prior to setup:*
  - Test all pushbuttons and ensure each is fully operational and corresponds to the correct function.
  - Test radio remote connectivity and batteries (if applicable).
  - Check to ensure that pneumatic tires (if applicable) are fully inflated to the level listed on the tire.
  - During operation, listen and check for any abnormal noise or vibration. This may be a sign of worn or broken parts that may need to be replaced.
- Inspect the slide rail elevating screw and ensure that it is in good operating condition. If necessary, clean with a mild de-greaser or alcohol based cleaner and lubricate with a silicon based lubricant.
- If the RRS-1 has been inactive for an extended period of time, check the battery voltage. If the voltage is below 24VDC the RRS-1 will need to be run using utility AC power, or be charged prior to use (charge time will vary depending on starting charge level).
- Ensure unit is free of dirt, dust, and grime by wiping down prior to operation.

### ATTENTION!

CBS ArcSafe® recommends that the RRS-1 remain plugged into AC power when not in use. The RRS-1 is equipped with a “smart charger” that will recognize battery voltage and automatically apply appropriate charging voltage without the need for setting the charger.

## 2.4.2 Location and Environment

Prior to beginning any remote racking procedure, users should be aware of the environment in which the operation will take place. This includes but is not limited to variables such as operational clearance, floor surface, and breaker condition.

- **Clearance** – Users should always note any potential clearance issues with the RRS-1 before getting started. This will help to avoid any potential problems during the operation when a clearance issue may cause interference between the breaker and/or RRS-1. Take into account breaker racking mechanism travel distance (For breakers with moving racking mechanisms only), racking tool length, and any obstacles that may interfere with the unit during its travel. If any issues exist, please contact CBS ArcSafe® for more information on application-specific solutions.
- **Arc Flash Boundary** – RRS-1 operators should familiarize themselves and always be conscious of the arc flash boundary of the equipment being operated. The arc flash boundary distance will vary depending on any number of factors including but not limited to: maximum short circuit current available, voltage, enclosure type and condition, and point of measurement. Based on these factors, an acceptable operating distance may be calculated for the safe operation of the equipment that will not endanger users in the event of an arc flash. CBS ArcSafe® recommends all users conduct an arc flash study to determine the potential hazards of the switchgear during an arc flash. Contact CBS ArcSafe® to learn more about arc flash study solutions and affiliated providers. For more information on arc flash calculations, PPE requirements, and safety regulations regarding arc flash, please see NFPA code 70E (<http://www.nfpa.org/>).

### **DANGER!**

Never use the RRS-1 to rack a breaker while personnel are stationed within the arc flash boundary. Ensure all personnel are safely outside of the arc flash boundary prior to operation. Ensure that all personnel using this equipment comply with all applicable Federal, State, Local, and In-House safety regulations and procedures. Special Attention should be given to distance, angle, and personal protective equipment (PPE).

- **Floor Surface** – If the RRS-1 will be racking a breaker with a moving racking mechanism the floor surface is an important variable. The RRS-1 will perform best on a flat and level surface. Surfaces consisting of gravel, dirt, or any uneven or unlevel surface may present problems for the RRS-1 during operation. If any of these issues exists please contact CBS ArcSafe® for more information.
- **Breaker Condition** – Another potential issue that must be examined prior to operation is the condition of the breaker that will be racked using the RRS-1®. Users should inspect the breaker racking mechanism for any signs of potential problems. Users should also check all safety interlocks to ensure that they are all working properly. If any problems are detected when inspecting the gear to be racked, CBS ArcSafe® strongly recommends that maintenance measures be taken prior to operating the electrical equipment. CBS ArcSafe® products are designed to operate with properly maintained and operable switchgear. CBS ArcSafe® makes no guarantee regarding the operation of its products on problematic switchgear.

## 3 Setup

This section will instruct users in the proper setup methods for the RRS-1 in order to perform a remote racking procedure. Please read Section 2 - Preparation prior to continuing.

### 3.1 Current Control Monitor

The Current Control Monitor (CCM) lies at the heart of the RRS-1's operation, providing both the user interface to input operational setpoints and the controller to monitor these settings during operation. The CCM display also provides users with the quantitative values needed for proper setup and operation of the RRS-1. In addition to these features, the CCM allows users to change the configuration of the RRS-1 to suit the racking operation being performed. This section describes the configuration, operation, and features of the RRS-1 CCM.

#### 3.1.1 CCM Identification

CBS ArcSafe® has manufactured RRS-1's with two different versions of the CCM. Depending on the age of the unit, the RRS-1 may have either of the two versions. This section will describe how to differentiate between the two main versions, as well as determine which firmware version is present in the CCM.

##### 3.1.1.1 CBS ArcSafe® CCM

The CBS ArcSafe® CCM (Shown in Figure 3-1) is the current version of CCM used on RRS-1 units. This version of the CCM is standard on all units purchased within the United States, the UK, and several other countries beginning in 2009, but was available in many locations prior to that time. For units purchased prior to 2009, please see Section 3.1.1.2 which deals with CBS ArcSafe®'s Legacy CCM to definitively verify the CCM version.



Figure 3-1: CBS ArcSafe® CCM

In order to add more functionality to the CBS ArcSafe® CCM, minor and major firmware revisions have been made since it was introduced. Throughout this document, references will be made to CCM firmware version for various functions. Users should be aware of which version of firmware is present on their RRS-1. The following procedure will describe how to identify which firmware version is present on an RRS-1's CCM.

1. Power on the RRS-1.
2. Observe the CCM display as the RRS-1 powers up. During power up the display will read "vX.X", where "X.X" is the firmware currently installed on the CBS ArcSafe® CCM.
3. After the firmware version is displayed for approximately 3 seconds the display will default to the home screen and read "0.0".

### **3.1.1.2 Legacy CCM**

The Legacy CCM (Shown in Figure 3-2) is the current version of CCM used on RRS-1 units sold in most countries outside of the United States and UK. The Legacy CCM was also installed on RRS-1 units sold within the United States prior to 2009. The Legacy CCM offers the same functionality as the CBS ArcSafe® CCM from an operational aspect, but lacks some of the features dealing with different CCM configurations. There is only one version of firmware used on the Legacy CCM; therefore, users do not need to worry about Legacy CCM firmware version identification.



**Figure 3-2:** CBS ArcSafe® Legacy CCM

### **3.1.2 CCM Configuration**

This section will detail the configuration of the CCM, including the layout and the functionality offered with each style.

#### **3.1.2.1 CBS ArcSafe® CCM**

This section will focus specifically on the configuration of the CBS ArcSafe® CCM.

### 3.1.2.1.1 CBS ArcSafe® CCM Layout

The CBS ArcSafe® CCM is comprised of several key items which allow users to interact with it by reading current values, setting current limits, and configuring certain aspects of the RRS-1's operation. The following image shows the user interface of the CBS ArcSafe® CCM and labels its major components.

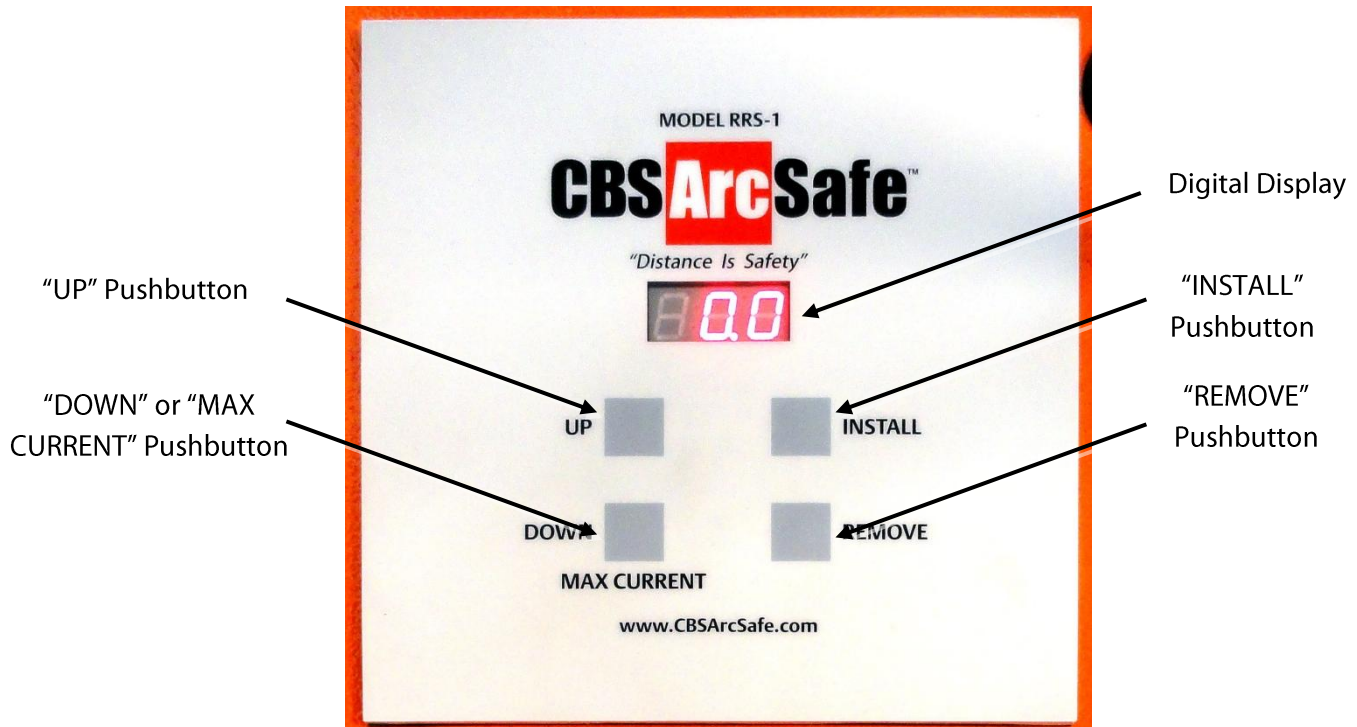

**Figure 3-3:** CBS ArcSafe® CCM configuration

### 3.1.2.1.2 CBS ArcSafe® CCM Function

Each component in the user interface of the CCM has a specific function. This section will explain the exact function of each to the user.

- **"UP" Pushbutton** – This button is used for increasing either the "INSTALL" or "REMOVE" current setpoint for automatic racking operations (see Section 3.1.4). It is also used as an adjustment button for advanced CCM setup (see Section 3.1.6).
- **"DOWN" or "MAX CURRENT" Pushbutton** – This button is used for decreasing either the "INSTALL" or "REMOVE" current setpoint for automatic operations (see Section 3.1.4). Pressing this button prior to an automatic racking operation will enable the CCM to record the maximum current reading and show it on the digital display throughout the operation. It is also used as an adjustment button for advanced CCM setup (see Section 3.1.6).
- **Digital Display** – The digital display is used for viewing and changing the current setpoints for the "INSTALL" and "REMOVE" operations as well as advanced CCM setup features. During an automatic racking operation it will display the instantaneous current reading (If "MAX CURRENT" has not been pressed).
- **"INSTALL" Pushbutton** – This button is used for making adjustments to the "INSTALL" direction settings for automatic racking operations. It is also used as a navigational button for advanced CCM setup (see Section 3.1.6).

- **“REMOVE” Pushbutton** – This button is used for making adjustments to the “REMOVE” direction settings for automatic racking operations. It is also used as a navigational button for advanced CCM setup (See section 3.1.6).

### 3.1.2.2 Legacy CCM

This section will focus specifically on the configuration of the CBS ArcSafe® Legacy CCM.

#### 3.1.2.2.1 CBS ArcSafe® Legacy CCM Layout

The CBS ArcSafe® Legacy style CCM operates differently than the standard CBS ArcSafe® CCM, however the basic functionality is still present. The user interface, while physically different, is quite similar in function to that of the standard CCM as well. The following image shows the user interface of the Legacy style CCM.



**Figure 3-4:** CBS ArcSafe® Legacy CCM configuration

#### 3.1.2.2.2 CBS ArcSafe® Legacy CCM Function

- **“SET 1” or “REMOVE” Dial** – This dial is used to adjust the “REMOVE” current setpoint used during automatic or manual (Set to “0.0”) racking operations.
- **“SET 1” or “REMOVE” Pushbutton** – This button is used to set the “REMOVE” current setpoint used during an automatic racking operation.
- **Digital Display** – The digital display is used for viewing and changing the current setpoints for the “INSTALL” and “REMOVE” operations. During an automatic racking it will display the instantaneous current reading.
- **“SET 2” or “INSTALL” Pushbutton** – This button is used to set the “INSTALL” current setpoint used during an automatic racking operation.
- **“SET 2” or “INSTALL” Dial** – This dial is used to adjust the “INSTALL” current setpoint used during automatic or manual (Set to “0.0”) racking operations.

### 3.1.3 Manual CCM Operation

Using the CCM in manual mode allows the user to monitor and record the current draw during the racking operation. Having this information simplifies setup of the CCM for future automatic operation. In order to run the RRS-1 in manual mode, the CCM setpoints must both be set to 0.0 amps. The following procedure will instruct the user how to set up the RRS-1 in manual mode.

1. Prior to operating the RRS-1 in manual mode, ensure that the RRS-1 has been properly set up as described in this manual.
2. Make note of which CCM is installed on the RRS-1. See Section 3.1.1 for information on identifying the CCM.
3. Power on the RRS-1. Ensure that the batteries are fully charged or the unit is plugged into AC power.
4. The digital LCD display will read the instantaneous current draw of the drive motor. When the unit is powered on, but not in operation, the CCM display should read "0.0".
5. To set the RRS-1 to operate in manual mode, both CCM setpoints must be set to 0.0. Check the current CCM setpoints:
  - a. *For the CBS ArcSafe® CCM*, press and hold the "INSTALL" soft button to view the INSTALL setpoint, or press and hold the "REMOVE" soft button to view the REMOVE setpoint. Release all buttons to return to the main display.
  - b. *For the Legacy CCM*, press and hold the small red "SET 2" button to view the INSTALL setpoint, or press and hold the small red "SET 1" button to view the REMOVE setpoint. Release all buttons to return to the main display.
6. Set the Install setpoint to 0.0 to operate in manual mode:
  - a. *For the CBS ArcSafe® CCM*, press and hold the "INSTALL" soft button, then repeatedly tap or hold the "DOWN" soft button until the display reads "0.0". Release both buttons to return to the main display.
  - b. *For the Legacy CCM*, press and hold the small red "SET 2" button, and turn the "SET 2" dial counter-clockwise until the display reads "0.0". The button should be illuminated red. Release the button to return to the main display.
7. Set the Remove setpoint to 0.0 to operate in manual mode:
  - a. *For the CBS ArcSafe® CCM*, press and hold the "REMOVE" soft button on the CCM panel, then repeatedly tap or hold the "DOWN" soft button until the display reads "0.0". Release both buttons to return to the main display.
  - b. *For the Legacy CCM*, press and hold the small red "SET 1" button on the CCM panel, and turn the "SET 1" dial counter-clockwise until the display reads "0.0". The button should be illuminated red. Release the button to return to the main display.

## ATTENTION!

With both the install and remove setpoints at 0.0 amps, the operator has momentary control over both the "INSTALL" and "REMOVE" operations.

8. During manual operation it is sometimes necessary to record the maximum current reading from the remote racking operation. To set the CCM to display the max current during operation:
  - a. For the CBS ArcSafe® CCM, press the "MAX CURRENT" soft button on the CCM. The decimal point on the display will flash, indicating to the user that the CCM is recording the max instantaneous value. Press the button again to stop recording and return to the main display.
  - b. For the Legacy CCM, it is unfortunately not possible to record the max operation current. Contact CBS ArcSafe® for more information.

## ATTENTION!

Monitoring and recording the maximum current draw on the CCM during the racking operation will allow for easier setting of the current control monitor for future Automatic remote rack operations.

9. With the CCM now properly set up, manual operation may begin. Please see Section 4 - Installation and Operation for directions on proper installation and operation of the RRS-1.
10. Once the RRS-1 has been properly set up for remote racking in manual mode, users should exit the arc flash boundary where the operation will take place.

## DANGER!

If using the RRS-1 in manual mode prevents the operator from exiting the arc flash boundary during the operation, please remember to comply with all applicable federal, state, local, and in-house safety regulations and procedures regarding arc flash. CBS ArcSafe® offers several options which allow users to monitor the CCM remotely if the operator is not in a position to view the remote racking operation.

11. To operate the RRS-1 in manual mode, press and hold the applicable "INSTALL" or "REMOVE" button on the wired pendant station or wireless pendant station (Optional). The RRS-1 will operate under momentary control until the user releases the button.
12. After operation is complete, follow the steps listed in Section 4 to remove the machine from the breaker, shut the machine down, and store the machine.

### 3.1.4 Automatic CCM Operation

This section will describe how to setup and operate the RRS-1 during an automatic racking operation. The following procedure will instruct the user how to set up the RRS-1 in automatic mode.

1. Prior to operating the RRS-1 in automatic mode, ensure that the RRS-1 has been properly set up as described in this manual.



2. Make note of which CCM is installed on the RRS-1. See Section 3.1.1 for information on identifying the CCM.
3. Power on the RRS-1. Ensure that the batteries are fully charged or the unit is plugged into AC power.
4. The digital LCD display will read the instantaneous current draw of the drive motor. When the unit is powered on, but not in operation, the CCM display should read "0.0".
5. Check the current CCM setpoints:
  - a. *For the CBS ArcSafe® CCM*, press and hold the "INSTALL" soft button to view the INSTALL setpoint, or press and hold the "REMOVE" soft button to view the REMOVE setpoint. Release all buttons to return to the main display.
  - b. *For the Legacy CCM*, press and hold the small red "SET 2" button to view the INSTALL setpoint, or press and hold the small red "SET 1" button to view the REMOVE setpoint. Release all buttons to return to the main display.
6. Set the Install setpoint to operate in automatic mode:
  - a. *For the CBS ArcSafe® CCM*, press and hold the "INSTALL" soft button, then repeatedly tap or hold the "UP" or "DOWN" soft button until the display reads the desired value. Release both buttons to return to the main display.
  - b. *For the Legacy CCM*, press and hold the small red "SET 2" button, and turn the "SET 2" dial clockwise or counter-clockwise until the display reads the desired value. Release the button to return to the main display.
7. Set the Remove setpoint to operate in automatic mode:
  - a. *For the CBS ArcSafe® CCM*, press and hold the "REMOVE" soft button on the CCM panel, then repeatedly tap or hold the "UP" or "DOWN" soft button until the display reads the desired value. Release both buttons to return to the main display.
  - b. *For the Legacy CCM*, press and hold the small red "SET 1" button on the CCM panel, and turn the "SET 1" dial clockwise or counter-clockwise until the display reads the desired value. Release the button to return to the main display.

## **DANGER!**

The required current setpoint for automatic operation may be determined by a number of factors, including but not limited to: breaker type, size, age, environment, and physical condition.

The recommended method to determine a suitable current setpoint is operational experience. However, users lacking experience may also find the required values by predetermining the current setpoint in manual operation. See Section 3.1.3 for more information on operation in manual mode.

8. With the CCM now properly set up, automatic operation may begin. Please see Section 4 - Installation and Operation for directions on proper installation and operation of the RRS-1.
9. Once the RRS-1 has been properly set up for remote racking in automatic mode, users should exit the arc flash boundary where the operation will take place.
10. To operate the RRS-1 in automatic mode, press and release the applicable "INSTALL" or "REMOVE" button on the wired pendant station or wireless pendant station (Optional). The RRS-1 will operate unaided until the current draw of the motor reaches the applicable setpoint. The remote racking operation may be stopped at any time by pressing either the red emergency stop button (labeled "ALL STOP" on the optional CCM radio remote) or by pressing the opposite "INSTALL" or "REMOVE" button on the pendant (i.e. if installing, press "REMOVE". If removing, press "INSTALL").
11. If the CCM and the RRS-1 have been set up properly, the racking operating will automatically cease when the breaker has been fully racked to its destination.
12. After automatic operation is complete, follow the steps listed in Section 4 to remove the machine from the breaker, shut the machine down, and store the machine.

### **3.1.5 CCM Status Indicator**

The CCM status indicator is a feature designed to alert the operator of the RRS-1's operational status from a distance and is comprised of a visual beacon and audible alarm. The CCM status indicator is a standard feature on all new CBS ArcSafe® RRS-1's and is available as an upgrade for any RRS-1 utilizing the CBS ArcSafe® style CCM (Unfortunately, this feature cannot be added to units utilizing the legacy style CCM; contact CBS ArcSafe® for more details). During operation, the beacon is illuminated to signal the user that a racking procedure is in progress. When the racking operation is complete, the beacon begins flashing, and the alarm begins sounding to signal the user that the racking operation has finished.

#### **3.1.5.1 CCM Status Indicator Components**

The CCM Status Indicator is made up of two main components – the indicating light and the audible alarm. The indicating light is located on top of the upper rail support. This LED beacon is meant to alert the operator of the RRS-1's operational status from a distance. The audible alarm is located on the side of the control cabinet. The alarm's piercing tone is designed to cut through the noise of industrial machinery to alert the operator of the RRS-1's operational status, even when the operator cannot see the RRS-1. The volume may be adjusted by rotating the red cover of the alarm to expose or cover the sounding element.



**Figure 3-5:** CCM Status Indicator indicating light



**Figure 3-6:** CCM Status Indicator audible alarm

### **3.1.5.2 CCM Status Indicator Operation**

This section will detail to the user how to discern between the CCM Status Indicator's signals before, during, and after remote operation.

1. Depending on the firmware version currently installed within the CCM, the CCM Status Indicator may act differently when the unit is powered on.
  - a. For firmware versions prior to v3.0, when powering on the RRS-1 unit the CCM Status Indicator indicating light will flash and the audible alarm will sound. This is meant to signal to all in the area that a remote racking operation is about to take place and to take appropriate actions. To

silence the alarm and turn off the beacon, the “RESET” button (located on the side of the control cabinet) may be pressed in order to reset the CCM Status Indicator and prepare the RRS-1 for racking.

- b. For firmware versions v3.0 and newer, the functionality of the CCM Status Indicator is hardwired directly into the CCM itself, and therefore will only give users an indication when the RRS-1 has reached an over-current condition, indicating the end of a racking operation.
2. Prior to operation, ensure that the CCM Status Indicator has been reset by checking that the indicating light is off and the audible alarm is not sounding.
  3. Upon beginning any remote racking operation, the indicating light will light up and remain lit solid during the duration of the operation. Upon completing the racking operation (When the CCM senses an over-current condition) the indicating light will change to a flash and the audible alarm will sound. If the RRS-1 has been properly set up for automatic racking on a functional breaker, this alarm will signify that the breaker has been fully racked to the applicable position.

## **DANGER!**

If the RRS-1 has not been set up properly, the CCM Status Indicator may give a false alarm. Therefore, it is extremely important for the RRS-1 to be setup properly according to Section 3.1.4 of this manual when racking in automatic mode. Please contact CBS ArcSafe® with any questions or concerns.

4. After the breaker has been completely racked, the user may reset the CCM Status Indicator. This step will depend on the firmware version installed within the CCM.
  - a. For firmware versions prior to v3.0, press the “RESET” button on the side of the control cabinet to reset the CCM Status Indicator. Pressing the “RESET” button will turn off the indicating light and silence the alarm. The RRS-1 is now ready to begin another remote racking operation.
  - b. For firmware versions v3.0 and newer, press any button on the pendant or radio remote (If equipped) to reset the CCM Status Indicator. Pressing any button on the pendant or radio remote (If equipped) will turn off the indicating light and silence the alarm. The RRS-1 is now ready to begin another remote racking operation.

### **3.1.6 Advanced CCM Features**

Within the CCM is the ability to configure several of the features and operational aspects of the RRS-1. Some of the features may or may not be applicable on the RRS-1 due to optional items and the CCM’s role in other CBS ArcSafe® products where these features are used. However, these will be noted below and users who mistakenly make modifications to these settings should not see any changes in the operation of the RRS-1. For any questions about the advanced setup of the CCM, please contact CBS ArcSafe®.

#### **3.1.6.1 Over-Current Delay Timer Setup**

One of the key features of using RRS-1 in automatic mode is being able to change the setting of the over-current delay timer. This parameter allows the user to set the amount of time that the running current is allowed to be greater than the current set point (In whichever direction the user is currently operating) before the RRS-1 shuts off operation. The range of values that users may set this value to range from 0.0 seconds to 0.9 seconds, in increments of .1 seconds (For CCM firmware versions older than 2.4, the available

range is 0.1 to 0.9 seconds). To change the over-current delay timer setpoint, please see the following instructions.

1. First, with the power on, press and hold both the "INSTALL" and "REMOVE" buttons on the CCM at the same time for approximately 5 seconds.
2. The display will now show the current set point for the over-current delay timer. To change the current set point, press the "UP" or "DOWN" buttons until the desired value has been reached.

### **ATTENTION!**

The RRS-1 over-current delay timer will come preset to 0.1 seconds. Changing this parameter will alter the operation of the RRS-1 during automatic racking operations. Please take caution when making changes to the over-current delay timer.

3. To exit, press either the "INSTALL" or "REMOVE" button. The new set point for the over-current delay timer will be automatically saved into memory. This setting will be saved even when the unit is powered off, eliminating the need to change the setting each time the unit is powered on.

### **3.1.6.2 Motor Direction Setup**

The RRS-1 is setup by default for clockwise (CW) operation on an "Install" command and CCW operation on a "Remove" command. If this does not match the operation of a specific piece of equipment and operators wish to change the motor direction please see the following steps:

1. First, with the power on, press and hold the "UP" and "DOWN" buttons together for approximately 5 seconds until the display reads either "nor" or "Rev". Normal (nor) operation is defined as CW rotation on the install direction and CCW in the remove direction. Reverse (rev) operation is defined as CCW rotation on the install direction and CW in the remove direction.
2. To change between the two options, press either the "UP" or "DOWN" buttons. Press the "UP" button to select Normal (nor) or the "DOWN" button to select Reverse (rev).
3. Once the desired setting has been made, press either the "INSTALL" or "REMOVE" button to advance to the next screen.
4. For versions older than 3.0, the previous command will bring the user back to the home screen. For versions 3.0 and newer there will be several other settings screens that follow. To skip these screens, simply press the "INSTALL" or "REMOVE" button without changing the setting.

### **3.1.6.3 Magne-blast Supervisory Link Coast-Down Timer Setup**

The Magne-blast Supervisory Link (MBSL) is an optional accessory for the RRS-1, and is described in "Appendix I: Magne-blast Supervisory Link" of this manual. The MBSL allows RRS-1 users to tether directly into the control circuit of the GE Magne-blast circuit breaker for remote racking operations. By doing this, the MBSL overrides control of the RRS-1 when the CCM is set to operate in manual mode (see Section 3.1.3 for details on Manual mode setup) and the MBSL cable is connected. The MBSL utilizes the internal control circuit of the Magne-blast cubicle consisting of several mechanical or mercury switches which limit the breaker travel during a racking operation with the legacy GE elevating motor. After a limit switch has been encountered during a racking operation using the RRS-1, the RRS-1 enters what is known as the "coast down" phase of the operation. Essentially, it adds a specified amount of time to the racking operation after

the limit switch has been triggered. The coast down phase is necessary due to the difference in operation between the legacy GE elevating motor and the CBS ArcSafe® RRS-1. This section will explain to the user how to adjust the coast down timers for use with the RRS-1 equipped with MBSL.

1. First, check the CCM firmware version currently being operated.
  - a. For versions older than 3.0, the coast down timer setting is not adjusted within the CCM interface. Please see Appendix I: Magne-blast Supervisory Link for more information.
  - b. For firmware version 3.0 and newer, the coast down timer is adjusted within the CCM interface. The following steps will explain how to adjust these settings.
2. Follow steps 1-3 in section 3.1.6.2 to arrive at the initial coast down timer setup screen. The display should read “n X.X” (Where “X.X” is the current setting). The lower case “n” on the display tells the user that this is the Install operation coast down timer setting. This setting may be set to any value between 0.1 and 2.0 seconds in 0.1 second increments by pressing the “UP” button to increase the time or “DOWN” button to decrease the time.
3. Press either “INSTALL” or REMOVE” to navigate to the next coast down timer screen. The display should read “r X.X” (Where “X.X” is the current setting). The lower case “r” on the display tells the user that this is the Remove operation coast down timer setting. This setting may be set to any value between 0.1 and 2.0 seconds in 0.1 second increments by pressing the “UP” button to increase the time or “DOWN” button to decrease the time.
4. Once the desired settings have been input, press either the “INSTALL” or “REMOVE” button to advance to the next screen.

#### **ATTENTION!**

For more information on MBSL setup and operation, please see Appendix I: Magne-blast Supervisory Link, which deals specifically with the MBSL feature.

#### **3.1.6.4 Jog Timer Setup**

The Low Speed Jog (LSJ) is an optional accessory for the RRS-1, and is described in “Appendix B: Low Speed/Jog”. The LSJ option gives users the ability to jog the drive motor for a specific amount of time each instance that the applicable jog button is pressed. This section will describe to users how to adjust this time interval for the Jog Install and Jog Remove operations.

1. First, check the CCM firmware version currently being operated.
  - a. For versions older than 3.0, the jog timer setting is not adjusted within the CCM interface. Contact CBS ArcSafe® for more information on setting the jog interval.
  - b. For version of firmware 3.0 and newer, the jog timer is adjusted within the CCM interface. The following steps will explain how to adjust these settings.
2. Follow steps 1-3 in section 3.1.6.2 and steps 3-4 in section 3.1.6.3 to arrive at the jog timer setup screen. The display should read “J .XX” (Where “.XX” is the current setting). The upper case “J” on the display tells the user that this is the jog timer setting. This setting may be set to any value

between .01 and .75 seconds in .01 second increments by pressing the “UP” button to increase the time or “DOWN” button to decrease the time.

3. Once the desired setting has been input, pressing either the “INSTALL” or “REMOVE” button will navigate the CCM to the next screen.
4. For CCM versions 3.4 or older, the previous command will bring the user back to the home screen. For CCM versions 3.5 and newer there will be one more function available as described in the next section.

### **ATTENTION!**

For more information on LSJ setup and operation, please see Appendix B: Low Speed/Jog which deals specifically with the LSJ feature.

#### **3.1.6.5 Output Sensing Shutdown**

In CCM firmware versions 3.5 and newer, the CCM adds functionality to detect whether or not a device is connected to the CCM output. This feature is used only on the RSO-IV product offered by CBS ArcSafe® and provides no added functionality on the RRS-1. See the following procedure on how to advance past this screen on the CCM display.

1. First, cycle through the steps in Sections 3.1.6.4 to navigate to the output sensing shutdown function screen within the CCM.
2. Once the user has navigated Output Sensing Shutdown setting, the screen will read either “nCE” or “nCd”. This feature is used only on the RSO-IV product offered by CBS ArcSafe® and provides no added functionality on the RRS-1.
3. Pressing either the “INSTALL” or “REMOVE” button will navigate the user back to the home screen.

## 3.2 Drive Assembly

The RRS-1's drive assembly may be adjusted to the different heights to interface with the breaker's racking mechanism. In addition to the adjustable height, the drive assembly's angle may be adjusted to compensate for uneven surfaces as well as extremely low racking mechanisms. This section will describe how to adjust the RRS-1's drive assembly.

### 3.2.1 Adjusting the Drive Assembly Height

This section will describe how to manually adjust the height of the drive assembly. This allows users to adjust for different height breaker racking mechanisms.

#### NOTE:

For users with the Power Slide option installed, please see section Appendix C: "Power Slide" for more information.

Use the following procedure to adjust the height of the RRS-1 drive assembly.

1. First, check to see if the hand crank has been installed on the unit. CBS ArcSafe® removes the hand crank prior to shipping in order to avoid any potential damage during transit. Users must install the hand crank prior to adjusting the drive assembly height. If the hand crank has not been installed, proceed onto step 2. If the hand crank has already been installed, proceed to step 4.

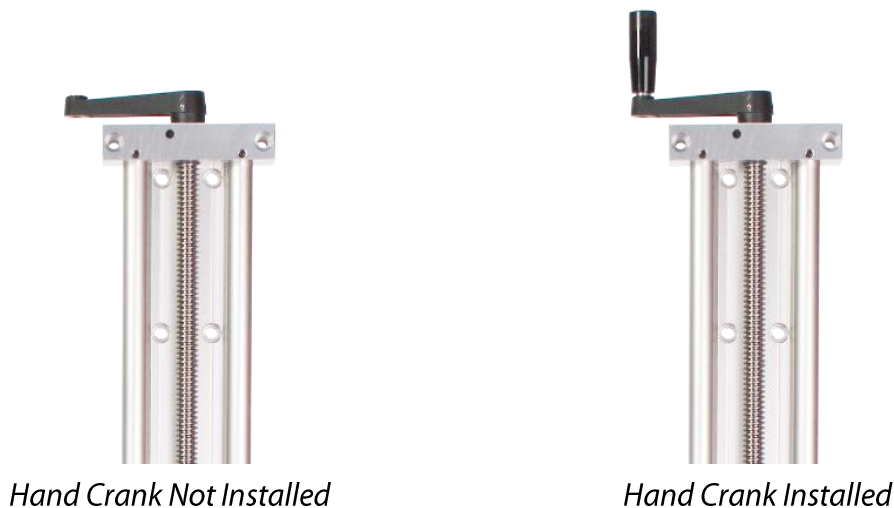

**Figure 3-7:** How to Determine if Hand Crank is Installed

2. Next, locate the hand crank in tool bag attached to the RRS-1. The hand crank is placed in the bag prior to shipping to keep it secure.
3. Carefully thread the base of the hand crank into the handle protruding from the RRS-1 slide rail assembly. Using a hex L-key, tighten the base of the hand crank into the handle, being careful not to over-tighten the fastener.
4. With the hand crank installed, users may now adjust the height of the drive assembly. Rotate the hand crank clockwise to raise the drive assembly. Rotate the hand crank counterclockwise to lower the drive assembly.



## ATTENTION!

Never operate the hand crank with tooling attached. The added length created by the tooling may cause interference with other objects. Always remove tooling prior to operating the hand crank.

### 3.2.2 Adjusting the Drive Assembly Angle

Adjusting the angle of the drive assembly allows users to account for uneven surfaces as well as interface with extremely low racking mechanisms. Follow the steps in the procedure below to adjust the angle of the RRS-1 drive assembly.

1. Locate the drive assembly mount which secures the motor/gearbox assembly to the slide rail. On the drive assembly mount there are three socket head cap screws which secure the gearbox to the mount itself. Adjusting these cap screws allow the drive assembly to be tilted. See the image below which shows these cap screws.

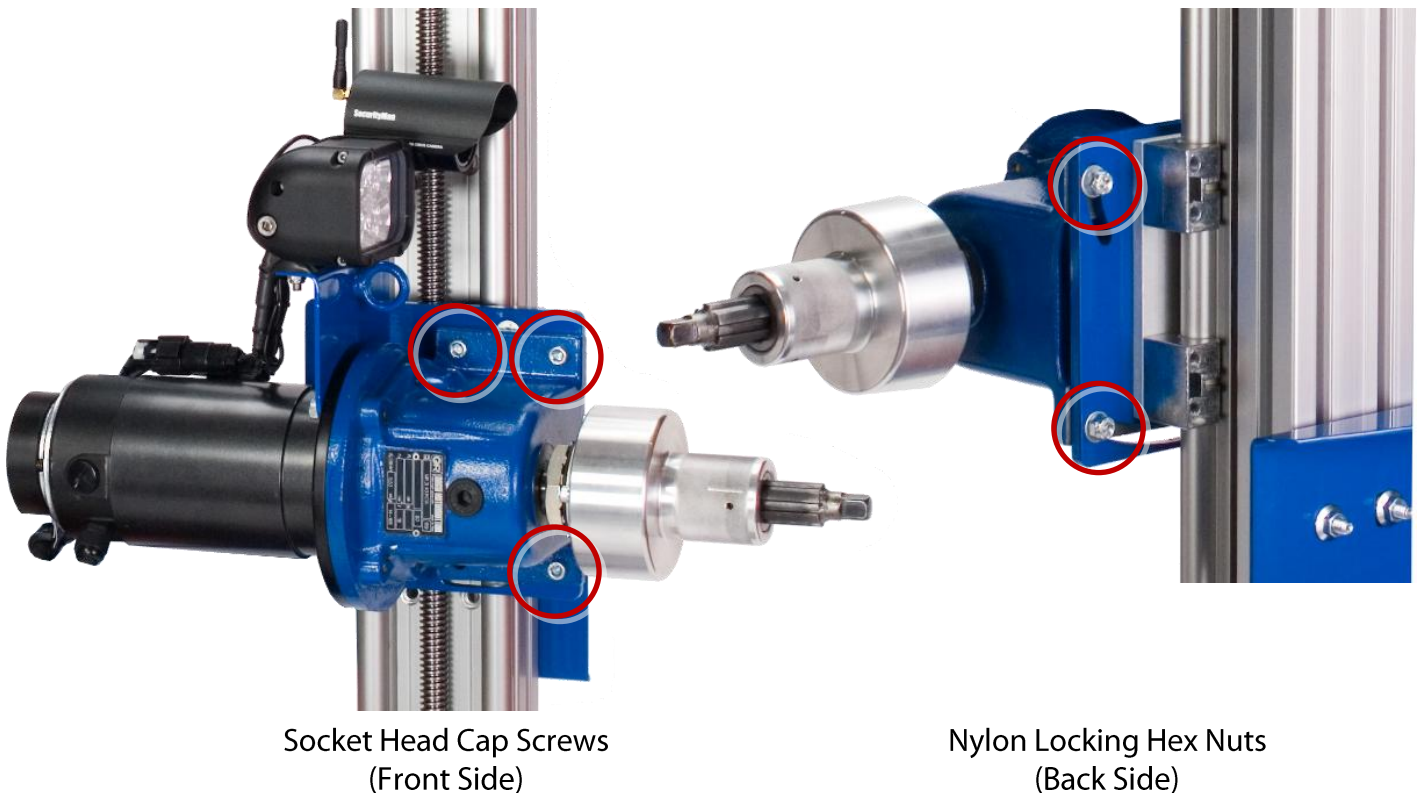

**Figure 3-8:** Drive Assembly Mount Fasteners

2. Using a hex L-key and an open end wrench, carefully loosen the two socket head cap screws which have a hex nut holding them in place from the back side.
3. Next, carefully loosen but do not remove the remaining socket head cap screw. The drive assembly pivots on this screw and the drive assembly angle may now be adjusted.
4. Once adjusted to the desired angle, re-tighten the pivot screw to temporarily hold the drive assembly in place. Re-tighten the two screws with nuts as well to lock the drive assembly in place.

## **ATTENTION!**

For users who wish to reach the minimum drive height possible with the RRS-1, tilt the drive assembly downward until it reaches its angular travel lengths. The drive head tilts down 30° to allow users to rack breakers with racking mechanisms less than 2.5" off of the floor. Users must use a universal joint in line with the tooling when operating with the drive head angled downward.

## **DANGER!**

Never leave the drive head angular adjustment loose. Leaving the fasteners which secure the motor assembly loose increases the risk of improper operation and damaged equipment. Always secure the fasteners after adjustment.

## 3.3 Torque Limiter

The torque limiter is designed to work in conjunction with the CCM to provide a dual-redundant safety system to reduce the possibility of damaging the circuit breaker racking mechanism. The torque limiter is attached to the drive head which mates with the racking tool.

### ATTENTION!

The torque limiter is set from the factory to 0 ft-lbs. In order to use the RRS-1, the torque limiter must be set to the proper amount of torque required for the breaker to be racked prior to being used for remote racking operations.

### 3.3.1 Finding Required Torque

This section will detail the tools required and the applicable steps to take in order to find the required amount of torque to rack a breaker.

#### 3.3.1.1 Required Tools

In order to find the amount of torque required to rack any style of breaker, CBS ArcSafe® has developed a procedure that will allow personnel to consistently and accurately measure this value. However, without the proper tools, this procedure cannot be performed and the user may risk damaging the racking mechanism due to an incorrect torque limiter setting. The tools required are as follows:

- De-energized switchgear (on a dead bus) with a properly maintained breaker racking mechanism in good working condition
- Adjustable click style torque wrench with minimum reading below 10 ft-lbs
- CBS ArcSafe® RRS-1 tooling for applicable breaker

#### 3.3.1.2 Finding Required Torque to Rack Breaker

In order to find the proper torque required to rack a certain style of breaker, a breaker in the OPEN position with a properly maintained racking mechanism in good working order on a de-energized bus must be racked by hand using the torque wrench. Follow these steps to determine the torque required to rack the breaker.

1. Ensure that the breaker to be racked is located on a de-energized bus and is in the OPEN position.

### DANGER!

NEVER perform this procedure on a live bus. This procedure calls for an interrupted and paused racking motion. If the breaker is located on a live bus, the possibility of faulty indicators or interlocks creates a very dangerous situation.

2. First, ensure that the breaker is in the "INSTALL" or fully racked position. If it is not, please rack the breaker to the install position.
3. Next, set the torque wrench to its minimum setting and attach the RRS-1 tooling to the torque wrench.

4. Now, using the torque wrench, rack the breaker out to the test/disconnect position. When the torque wrench “clicks” or gives an over-torque indication, increase the allowable torque by 1 ft-lb. When the breaker reaches either the test or disconnected position the torque will suddenly increase as interlocks and mechanical limits are engaged. Do not mistake this value of torque as the maximum value required to rack the breaker. Record the value of torque measured prior to encountering the hard stops.
5. Next, reset the torque wrench to the minimum setting and begin installing the breaker. When the torque wrench “clicks” or gives an over-torque indication, increase the allowable torque by 1 ft-lb. When the breaker reaches the installed or fully connected position the torque will suddenly increase as interlocks and mechanical limits are engaged. Do not mistake this value of torque as the maximum value required to rack the breaker. Record the value of torque measured prior to encountering the hard stops.
6. Generally, the maximum value required for racking a breaker in and out will be found when the breaker begins to contact the stabs when being racked in. Record this maximum value, as it will be needed to set the torque limiter to the proper amount of allowable torque.

### **DANGER!**

As breakers age and/or do not see regular maintenance, the torque required to rack a breaker may increase. However, a large increase in torque required to rack a breaker, including amounts over 10% of the average torque, may indicate breaker problems.

In many instances, these breakers that require more torque to rack tend to have defective mechanics. These issues may be signs of more serious problems that require immediate attention (Possibly including broken shutters, defective interlocks, and malfunctioning racking assemblies). Contact a local Group CBS® representative to inquire about breaker maintenance and/or replacement parts.

## **3.3.2 Setting the Torque Limiter**

When properly set, the torque limiter should slip slightly at the moment the breaker is either fully installed or removed as the CCM shuts off after an automatic remote racking operation. If the torque limiter is set too low, it will slip excessively during and after the remote racking operation. If the torque limiter is set too high, it will not slip at the end of the operation and put unnecessary stress on the breaker racking mechanism. This section will describe the required tools to adjust the torque limiter and the steps to do so.

### **3.3.2.1 Required Tools**

The following tools are required for making accurate adjustments to the torque limiter:

- Adjustable click-style torque wrench with minimum reading below 10 ft-lbs
- Torque limiter adjustment wrench (Provided with RRS-1)

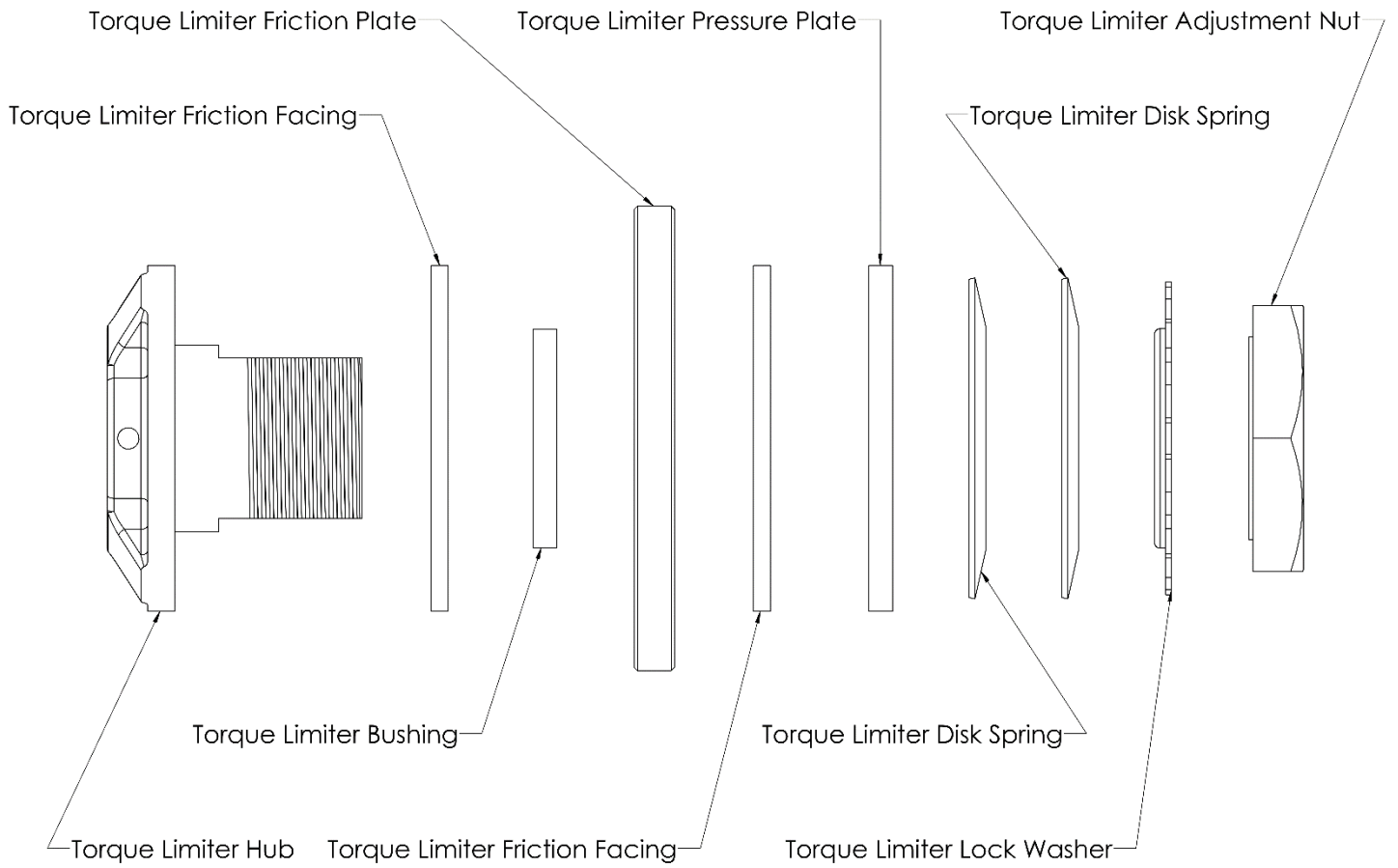

**Figure 3-9:** Torque wrench and torque limiter adjustment wrench

### **3.3.2.2 Setting the Torque Limiter**

This procedure will illustrate how to set the torque limiter to the desired value for remote racking operations.

1. Power on the RRS-1 and ensure that the batteries are fully charged or that the unit is running on AC power.
2. Next, turn the “BRAKE” switch on the top side of the control cabinet to the “ON” position. When this is done, users should hear a small “click” sound from the backside of the drive motor – this indicates that the brake is locked in.
3. Attach the torque wrench to the spring loaded drive head (Various different socket adapters may be necessary depending on the drive size of the torque wrench) and use the torque wrench to determine the present setting of the torque limiter.
4. Once this value is known, use the torque limiter adjustment wrench to either loosen or tighten the torque limiter adjustment nut as needed. Turning the adjustment nut clockwise or tightening it will increase the torque value, while turning it counterclockwise or loosening it will decrease the torque value.
5. Check the new torque value to ensure that it is correct. Repeat steps 3 and 4 as necessary until the proper torque setting is recorded.



**Figure 3-10:** Torque limiter assembly schematic

### 3.4 Control Cabinet

The primary function of the RRS-1 control cabinet is to house and protect the all vital control and operation wiring and components. In addition to housing control and operation components, the RRS-1's power supply is mounted to the bottom surface of the control cabinet. The top surface of the control cabinet houses the user interface for all functions except remote operation (These "local" functions include CCM adjustments, control over the RRS-1 brake, as well as controls for various other optional accessories). This section will detail each specific component of the RRS-1 control cabinet as well as describe the operation of the component where applicable.



**Figure 3-11:** RRS-1 Control cabinet

### 3.4.1 Control Cabinet Components



- |                             |                           |                                |
|-----------------------------|---------------------------|--------------------------------|
| 1. Power Slide Motor Cable  | 8. MBSL Cable Receptacle  | 14. Power Supply               |
| 2. "LIGHT" Switch           | 9. Current Control Module | 15. CCM Status Indicator Siren |
| 3. "CAMERA" Switch          | 10. CCM Status Indicator  | 16. Control Cabinet Latch      |
| 4. "BRAKE" Switch           | 11. Power Indicator Light | 17. AC Power Indicator Light   |
| 5. Auxiliary Power Cable    | 12. Main Power Disconnect | 18. AC Power Input Receptacle  |
| 6. Motor Power Cable        | 13. Serial Plate          |                                |
| 7. Wired Pendant Receptacle |                           |                                |

Figure 3-12: Control Cabinet Components



1. **Power Slide Motor Cable ( Figure 3-12.1 )** – On RRS-1 units equipped with the Power Slide option, this plastic cover will be replaced with the power cable which runs the power slide motor. On standard RRS-1 units not equipped with this option a black plastic cover will be installed. Please see “Appendix C: Power Slide” for more information regarding this option.
2. **“LIGHT” Switch ( Figure 3-12.2 )** – On RRS-1 units equipped with the LED Light option, this plastic cover will be replaced with a switch which will control the LED Light. On standard RRS-1 units not equipped with this option a black plastic cover will be installed. Please see Appendix E: LED Light for more information regarding this option.
3. **“CAMERA” Switch ( Figure 3-12.3 )** – On RRS-1 units equipped with the camera option, this plastic cover will be replaced with a switch which will control the camera. On standard RRS-1 units not equipped with this option a black plastic cover will be installed. Please see Appendix F: Camera System for more information regarding this option.
4. **“BRAKE” Switch ( Figure 3-12.4 )** – This switch controls the RRS-1 drive motor brake. The RRS-1 drive motor is equipped with an electromagnetic brake which prohibits any rotary motion of the drive assembly when it is engaged. (NOTE: The brake is engaged or “ON” when power to the brake has been removed and the brake is disengaged or “OFF” when power is supplied to the brake. It is for this reason that the brake will be engaged or “ON” when the RRS-1 is powered off). When the brake control switch is in the “ON” position, the brake will automatically engage itself when the signal is given to stop the motor, thus limiting any over travel of the motor. In order to rotate the drive assembly by hand, the main power must be “ON” and the brake control switch must be “OFF”.
5. **Auxiliary Power Cable ( Figure 3-12.5 )** – On RRS-1 units equipped with either the LED Light and/or Camera option, this plastic cover will be replaced with the cable which supplies power to them. On standard RRS-1 units not equipped with either of these options, a black plastic cover will be installed in this location.
6. **Motor Power Cable ( Figure 3-12.6 )** – This coil cable provides power to the drive motor. The coil cable allows to the motor to move freely up and down on the height adjustment rail without interference or restrictions.
7. **Wired Pendant Receptacle ( Figure 3-12.7 )** – The wired pendant coil cord which plugs into the wired pendant receptacle allows the operator of the RRS-1 to distance themselves from the breaker during the install and remove operations. The threaded connection allows for quick and simple removal of the cord and pendant for storage, or to add a cord extension.
8. **MBSL Cable Receptacle ( Figure 3-12.8 )** – The MBSL cable receptacle is located on the top side of the control cabinet on all MBSL equipped units. This four pin threaded receptacle is used to interface between the RRS-1 and the Magne-blast control circuit for MBSL operation. The connection is made by connecting the applicable end of the MBSL cable to both the Magne-blast cubicle and the RRS-1. See “Appendix I: Magne-blast Supervisory Link” for more information.
9. **Current Control Monitor (CCM) ( Figure 3-12.9 )** – The Current Control Monitor (CCM) serves as the brains of the RRS-1 during remote racking operations as well as the user interface for changing any settings. For more information about the CCM, its setup and functionality, and its user interface and button layout, please see Section 3.1.

10. **CCM Status Indicator Cable ( Figure 3-12.10 )** – This cable powers the CCM Status Indicator beacon near the top of the RRS-1. The cable is run up the frame and secured to the frame to prevent it from coming loose.
11. **Power Indicator Light ( Figure 3-12.11 )** – The power indication light signals to the user if the RRS-1 is powered on or off. The power indication light is near the main power disconnect and is labeled “POWER ON”. When the main power disconnect is in the “ON” position, the power indication light should be illuminated. When the main power disconnect is in the “OFF” position the power indication light should not be illuminated.
12. **Main Power Disconnect ( Figure 3-12.12 )** – The main power disconnect is located on the left side of the control cabinet (Or on the backside on older RRS-1 units). The main power disconnect controls the power to all functions of the RRS-1. The main power disconnect must be in the “ON” position to operate the RRS-1.
13. **Serial Plate ( Figure 3-12.13 )** – The serial plate shows the serial number of the RRS-1. In addition to the serial number, the plate contains some contact information for CBS ArcSafe®.
14. **Power Supply ( Figure 3-12.14 )** – The RRS-1 power supply provides both the battery charging capabilities and the AC operation capabilities to the unit. When plugged into AC power, the power supply will work to charge the batteries unless called upon to provide additional power to operate the machine in the event that the battery charge is not sufficient to operate it. Power standards vary across the globe and the power supply included with the RRS-1 will match standards for its destination.
15. **CCM Status Indicator Siren ( Figure 3-12.15 )** – The CCM status indicator emits a piercing tone when a racking operation is complete. The volume of the siren may be adjusted by rotating the siren’s exterior housing and exposing or covering the sounding element.
16. **Control Cabinet Latch ( Figure 3-12.16 )** – The control cabinet latch restricts entry into the control cabinet. However, if users must enter the control cabinet, it may be opened using a flat-head screwdriver to rotate the lock 90° counterclockwise. The control cabinet houses the control wiring and batteries for the RRS-1 and should only be opened by trained CBS ArcSafe® personnel.
17. **AC Power Indicator Light ( Figure 3-12.17 )** – The red light above the AC Power Receptacle will illuminate when AC voltage is present.
18. **AC Power Input Receptacle ( Figure 3-12.18 )** – The AC power input receptacle is located near the bottom of the control cabinet on the right side. In order to charge the batteries or run the RRS-1 using AC power, users will have to plug the supplied power cable into this receptacle. Power standards vary across the globe and the RRS-1 power supply and corresponding label identifying acceptable input power will match standards for its destination.

## 3.5 Tether Kit

The tether kit is used to provide a universal link between the RRS-1 and the electrical equipment being operated. This section will describe to users the components of the tether kit, when to use the tether kit, and how to use the tether kit.

### 3.5.1 Tether Kit Components

The following image shows the components which make up the standard tether kit. Please see the following list for a brief description of each component.



**Figure 3-13:** Tether kit components

1. **Tether Kit Magnet ( Figure 3-13.1 )** – The tether kit magnet is used to mate the tether kit system to the electrical equipment side of the operation. The magnet provides a strong yet easily removable and highly customizable means of attaching to the electrical equipment.
2. **Tether Kit Bungee Cords ( Figure 3-13.2 )** – The tether kit bungee cords provide the link between the RRS-1 tether bracket and the tether kit magnet. Several sizes of bungee cords are included in this kit to accommodate a wide variety of applications.
3. **Tether Kit Storage Bag ( Figure 3-13.3 )** – The tether kit storage bag is used to house the tether kit magnet and the tether kit bungee cords. The tether kit storage bag may be stored in the RRS-1 storage bag when not in use.

### 3.5.2 When to Use the Tether Kit

This section will instruct users on when it is appropriate (or required) to use the tether kit.

- *Breakers with moving racking mechanisms* – Use the tether kit when racking breakers which utilize a moving racking mechanism. A moving racking mechanism is one which moves with the breaker

throughout its travel as it is being racked. As the racking mechanism moves, the RRS-1 must move with it. In order for the RRS-1 to remain tethered to the breaker being racked, the tether kit must be connected between the two to provide this link.

- *When racking without tether free tooling* – CBS ArcSafe® provides tether free tooling as an upgrade to most standard tooling. Tether free tools do not require the use of the tether kit as they provide the link between the breaker and the unit themselves. Tether free tooling is available for most low and medium voltage circuit breakers. Please contact CBS ArcSafe for more information regarding tether free tooling availability for a specific application.

### 3.5.3 Tether Kit Setup and Use

This section will instruct users on the setup and use of the tether kit.

#### 3.5.3.1 Tether Kit Setup

Setting up the tether kit is quite simple and takes technicians only seconds to do so. Please follow these steps which instruct users on how to install the tether kit.

Prior to installing the tether kit, ensure that the following conditions are met (See Section 4.2 - Installation for details on installation of the RRS-1):

1. The spring loaded drive head of the RRS-1 is aligned to the breaker's racking mechanism and that both the vertical and horizontal alignments are correct.
2. The applicable tooling is attached to the breaker racking mechanism and the spring-loaded drive head on the RRS-1.

Next, couple the RRS-1's movement to the breaker using the tether kit.

1. First, attach the tether magnet to the breaker or other metallic surface somewhere near the racking mechanism. Be sure not to mount the magnet in any location which may cause interference when racking the breaker. Secure the magnet to the surface by rotating the ring 180° clockwise.
2. Secure the RRS-1 to the tether magnet using the appropriate length provided bungee cord. Connect the bungee cord to the tether magnet ring first and then to the tether bracket ring found on the RRS-1 drive assembly.
3. Ensure that the tether bungee provides sufficient force to engage the RRS-1 tooling to the racking mechanism completely.

#### **DANGER!**

Some breakers are equipped with spring loaded interlocks which must be depressed prior to racking. Ensure that the bungee force is sufficient to depress all applicable interlocks. If bungee force is not enough to engage interlocks, remove the current bungee and install the next size shorter bungee in place to provide more force. If issues persist, contact CBS ArcSafe® for support.

4. The tether kit is now properly installed.

## 4 Installation and Operation

Once the RRS-1 has been properly setup according to the procedures outlined in Section 3 of this manual, remote operation may begin. This section will detail the necessary requirements that must be met before a remote racking operation may begin as well as the steps necessary to perform the remote racking operation.

### 4.1 Requirements for Remote Racking

This section will describe the requirements that must be met before any racking procedure can begin to install or remove the circuit breaker. Before performing the installation procedure, please ensure that the following prerequisites have been met:

1. The circuit breaker racking mechanism is in working order.
2. The circuit breaker has been properly maintained.
3. The circuit breaker is in the appropriate position for the operation to be performed.
4. The circuit breaker is OPEN according to manufacturer specifications.
5. The RRS-1 has been setup properly according to the procedures in Section 3.

#### **DANGER!**

Please ensure that all personnel follow the personal protective equipment (PPE) rules and regulations along with following all of the manufacturer guidelines at ALL times.

### 4.2 Installation

This section will describe the necessary steps to install the RRS-1 onto the circuit breaker prior to remote racking

1. Ensure that all of the requirements outlined in section 4.1 have been met; and ensure that the RRS-1 has been setup properly as outlined in Section 3.

#### **DANGER!**

Users must setup the unit according to the procedures outlined in Section 3. The CCM, torque limiter, control cabinet, and tether kit must all be configured for the breaker being racked. If any of these items are not setup correctly, users may experience improper operation and machine or circuit breaker damage, resulting in operator injury or death.

2. Power the unit on and ensure that the RRS-1's batteries are fully charged or the unit is running on AC power.
3. If a tooling guide was included with the applicable tooling, check the installation section of the guide now for any special steps that may apply only to this application. If no tooling guide was included please continue to the next step.

## ATTENTION!

Remote operation of some electrical equipment may require the use of additional tooling beyond the standard tool provided by CBS ArcSafe® (For example, remote interlock defeats). If users do not possess all equipment necessary for remote operation please contact CBS ArcSafe®.

4. Next, position the RRS-1 in front of the breaker to be racked and perform the following steps to install the RRS-1 tooling onto the breaker.
  - a. Align the spring loaded drive head of the RRS-1 to the breaker's racking mechanism. Ensure that both the vertical and horizontal alignments are correct before proceeding.
  - b. Next, attach the applicable tooling to the breaker racking mechanism and ensure that it is the proper tooling for the breaker. Wheel the RRS-1 forward to engage the tooling (If the breaker racking mechanism is spring loaded the tool may not stay on, instead attach the tooling first to the RRS-1 spring loaded drive head). Ensure that the motor brake on the RRS-1 is "OFF" to allow the operator to orient the drive head to the tool.
  - c. Attach the tooling to the spring loaded drive head. Ensure that the spring ball on the drive head locks into place, securing the tool to the drive head (NOTE: For international units and units purchased prior to 2010, there is no locking feature on the drive head, contact CBS ArcSafe® for information regarding this upgrade).
  - d. Next, fix the RRS-1's movement based on which style of breaker racking mechanism is being operated. For a moving breaker racking mechanism, attach the tether kit to the breaker in a place that will not cause interference. Secure the RRS-1 to the breaker using the provided bungee cords (See section 3.5 for instructions on tether kit usage). For a stationary breaker engage the floor locks.
5. Once the tooling is installed properly, the RRS-1 should either be tethered to the breaker or locked in place using the floor locks. If included with the tooling, check the applicable tooling guide for the appropriate RRS-1 motor brake settings. If no tooling guide or brake settings are found, then users should turn the motor brake control switch to the "ON" position.

## ATTENTION!

The RRS-1 motor brake prevents the motor from over rotating and is necessary for most racking operations. For breaker specific brake settings, consult any tooling-specific guides or contact CBS ArcSafe®.

6. Again, verify the circuit breaker is OPEN according to manufacturer specifications and company safety policies.

## 4.3 Operation

This section will educate users on the proper operation procedures for the RRS-1.

1. Ensure that all of the requirements outlined in Section 4.1 have been met; ensure that the RRS-1 has been setup properly as outlined in Section 3; and ensure that the unit has been installed as outlined in Section 4.2.
2. Next, ensure that the CCM is properly set up for the desired operation:
  - a. To rack a breaker in manual mode, please ensure that the CCM is set to “0.0” in the applicable “INSTALL” and/or “REMOVE” directions. Please see Section 3.1.3 for instruction on how to perform this task.
  - b. To rack a breaker in automatic mode: ensure that the CCM setpoints are set to the appropriate values for the applicable “INSTALL” and/or “REMOVE” directions. Please see Section 3.1.4 for instruction on how to perform this task.
3. Exit the arc flash boundary with the applicable pendant station.

### **DANGER!**

Exiting the arc flash boundary may prevent the operator from observing the circuit breaker during repositioning, if this situation occurs we recommend acquiring the CBS ArcSafe® camera system in order to remotely view the repositioning.

Although the pendant station allows the operator to be away from the immediate arc flash boundary, personal protective equipment requirements must still be met at all times.

4. If a tooling guide was included with the applicable tooling, check the operation section of the guide now for any special steps that may apply only to this application. If no tooling guide was included please continue to the next step.
5. After performing any necessary steps dictated by the tooling guide, remote operation may begin.
  - a. If operating in manual mode, press and hold the “INSTALL” or “REMOVE” button corresponding to the operation to be performed. Because the RRS-1 is in manual mode, this is a momentary operation – meaning that the unit will operate only as long as the operator is pressing the applicable “INSTALL” or “REMOVE” button.
  - b. If operating in automatic mode, press and release the “INSTALL” or “REMOVE” button corresponding to the operation to be performed. Because the RRS-1 is in automatic mode, the unit will operate in the specified direction until it reaches the applicable current setpoint

### **DANGER!**

If, during a racking operation, the unit’s system voltage drops below the minimum voltage necessary for operation, the unit will complete the racking operation being performed, but the CCM will lock out further operation until the batteries have been charged and the power has been cycled.

## **DANGER!**

If remote operation of the applicable electrical equipment requires an interlock to be defeated, ensure that personnel do not enter the arc flash boundary during operation to manually do so.

CBS ArcSafe® also provides customized solutions for remote interlock defeats for various electrical equipment. Contact CBS ArcSafe® to learn more.

6. After the operation is complete:
  - a. If operating in manual mode, if the torque limiter has been setup correctly it will begin to “slip” at the end of the racking process as the racking mechanism encounters a hard stop. At this point the user may release the button to stop rotation of the drive motor.
  - b. If operating in automatic mode and the CCM has been properly configured, the RRS-1 will cease operation end of the racking process as the racking mechanism encounters a hard stop.
7. Users may now reenter the arc flash boundary and visually inspect the circuit breaker to ensure that it has fully completed its operation and is resting in the fully Installed or Removed position (Or in the Test position depending on the operation performed). Once it has been verified that the breaker successfully completed the full operation, users may approach the RRS-1 and breaker.
8. To immediately perform another operation, reset the CCM Status indicator (See section 3.1.5).
  - a. For CCM firmware v3.0 and below, press the reset button on the CCM cabinet.
  - b. For CCM firmware v3.0 and above, press any key on the remote pendant or radio remote.
9. Detach and uninstall the RRS-1 unit from the circuit breaker cubicle as follows:
  - a. Depress the emergency stop button to prevent any accidental operation from occurring.
  - b. Replace the applicable pendant station used for remote operation to its appropriate position on the RRS-1.
  - c. Turn the motor brake control switch on the top side of the control cabinet to the “OFF” position.

## **ATTENTION!**

The RRS-1 motor brake will maintain pressure on the circuit breaker racking device after the racking operation is complete. Switching the motor brake to the “OFF” position will relax the system and allow the RRS to be removed from the breaker easily.

- d. Disengage the foot brakes or tether kit depending on the configuration used to rack the breaker.



- e. Carefully remove the circuit breaker racking tooling from the RRS-1 drive head, then remove the circuit breaker racking tooling from the breaker.
10. If applicable, lower the drive assembly to a suitable position for transportation and storage.
  11. Turn the main disconnect to the "OFF" position.
  12. Plug in the RRS-1 using the supplied charging cord and cover the unit with the provided dust cover. Store the unit in a clean, dry location for future use.

# 5 Maintenance & Inspection

## **DANGER!**

The RRS-1 unit and any included accessories or options are not intended to be repaired by the customer. If any damage which requires repair is incurred on any of these items, please contact CBS ArcSafe®.

The CBS ArcSafe® RRS-1 remote racking system is designed to be a robust and reliable unit. However, adopting a regular maintenance and inspection schedule will keep the RRS-1 in peak condition for the life of this product, providing years of trouble free service.

## **5.1 Prior to Use**

Before each use, examine the overall condition of the unit, noting anything that may adversely affect operation. This practice will help to prevent the operator from setting up and/or operating a unit that shows any signs of misuse which may lead to improper operation. Contact CBS ArcSafe® immediately if any of these issues are found. Several key points to check for mistreatment or damage include, but are not limited to:

- Inspect all plugs, receptacles, and cord grips for any damage. To ensure a proper connection is made, tighten connections where necessary.
- Inspect all cables for wear or damage. Replace any damaged cable immediately by contacting CBS ArcSafe®.
- Check for any loose or missing hardware, and retighten or replace as necessary.
- Check the drive assembly for any signs of leaking oil/grease. If the unit has not been operated for an extended period of time, the oil may separate out of the grease and leak out of the motor/gearbox interface. Be sure to exercise the motor often to keep this from occurring.
- Power up and run the unit to ensure all functionality is working properly prior to setup.
  - Test all pushbuttons and ensure each is fully operational and corresponds to the correct function.
  - Test radio remote connectivity and batteries (if applicable).
  - Test the Emergency Stop functionality on the wired pendant and (If applicable) wireless pendant.
  - During operation, listen and check for any abnormal noise or vibration. This may be a sign of worn or broken parts.

- Inspect the slide rail elevating screw and ensure that it is in good operating condition. If necessary, clean with a mild de-greaser or alcohol based cleaner and lubricate with a silicon based lubricant.
- Check to ensure that pneumatic tires (if applicable) are inflated to 24psi.
- If the RRS-1 has been inactive for an extended period of time, check the battery voltage. If the voltage is below 24VDC, the RRS-1 will need to be run using 120VAC or charged prior to use (charge time will vary depending on starting charge level).
- Ensure unit is free of dirt, dust, and grime by wiping down prior to operation.

## **5.2 After Use**

After each use, inspect the unit to ensure that no damage was incurred during the most recent operation. Test and inspect all mechanical and electrical components to ensure that each is fully functioning for future use. Ensure that the unit is free of dirt, oil, and/or grease; and, if necessary, clean the unit prior to storage. Place any and all additional components neatly into the attached storage bag while ensuring cables are properly coiled and free of tangles. Store the unit using the provided dust cover (Or optional water resistant cover) in a clean and dry location to prevent damage when not in use.

## **5.3 Yearly Maintenance**

Depending on usage, at least once a year perform the checklists and regular maintenance listed in the two previous sections. If usage is frequent, make sure to carefully check all wear items and replace as necessary.

## 5.4 Basic Troubleshooting Guide

### DANGER!

The information in this service guide is intended for use by individuals possessing adequate backgrounds and experience in electrical, electronic, and mechanical systems. Any attempt to repair a CBS ArcSafe® product may result in personal injury and property damage. The manufacturer or seller cannot be responsible for the interpretation of this information, nor can it assume any liability in connection with its use.

Issue	Cause	Solution
The system power will not energize when the main disconnect is in the ON position and running off of battery power only (Not plugged into AC power).	The emergency stop pushbutton on the wired pendant has been depressed.	Reset the emergency stop pushbutton on the wired pendant. See Section 1.3.2 for more information..
	The batteries are completely discharged.	Plug the unit into AC power and allow it to charge prior to operation.
	Wiring inside the control cabinet has become disconnected.	Open the control cabinet and inspect connections for loose or disconnected wires.
The system will not energize when the main disconnect is in the ON position or will not charge the batteries when connected to AC power.	AC power source is not functional or is not compatible with unit.	Check the AC power connection and contact CBS ArcSafe.
	The emergency stop pushbutton on the wired pendant has been depressed.	Reset the emergency stop pushbutton on the wired pendant. See Section 1.3.2 for more information..
	Wiring inside the control cabinet has become disconnected.	Open the control cabinet and inspect connections for loose or disconnected wires.
	Batteries are no longer able to hold a charge.	Contact CBS ArcSafe to order replacement batteries.
The RRS-1 will not rack the breaker.	There is an issue with the circuit breaker racking mechanism.	Troubleshoot the switchgear; ensure the breaker is open and all interlocks are satisfied.
	The drive motor rotates, but the torque limiter slips.	Increase the torque limit on the mechanical torque limiter. See section 3.3.2.
	The tooling is not installed properly or engaged fully into the breaker racking mechanism.	Refer to tooling guide if available for proper tooling installation instructions. If not tooling guide available contact CBS ArcSafe® for more information.

### DANGER!

To avoid personal injury, disconnect power before servicing this product. If electrical power is required for diagnosis or test purposes, disconnect the power immediately after performing the necessary checks.

# Appendix A: Options & Accessories

The RRS-1 unit comes standard with all features and functionality described in this manual up to this point. However, a majority of customers choose to purchase additional options and upgrades for the RRS-1. Depending on the customer and the application, these options may be purchased to improve and simplify the remote racking operation or to comply with any applicable federal, state, local, and/or in-house safety regulations or procedures. However, some options listed in this section may be required or strongly recommended by CBS ArcSafe® for remote operation depending on the application; contact CBS ArcSafe® with any questions.

Several of the available options are aimed at providing users the maximum amount of flexibility in one unit. Users who plan to rack multiple types of gear built by multiple manufacturers may benefit from any of these options which allow them to purchase one unit to rack all of their gear. Other options are aimed at giving the operator greater flexibility in the way in which they operate the unit to remotely rack the circuit breakers. Still other options are available to help the operators better monitor the remote racking procedure, ensuring that they perform the action safely and efficiently.

All options and upgrades are available for purchase at the time of unit purchase or after the fact. Depending on which options are being purchased and which options are already installed on the machine, CBS ArcSafe® may send a field representative to install the newly purchased options or require that the machine be sent back to the CBS ArcSafe® facility. In special circumstances CBS ArcSafe® may allow the customer to install the option themselves, contact CBS ArcSafe® for more information.

If a customer is looking for an option or upgrade that is not listed in this section, contact CBS ArcSafe®. CBS ArcSafe® is constantly working with its customers to provide customized solutions for each situation. CBS ArcSafe® has built many custom solutions not listed in this section for customers who have requirements beyond that of the average customer. CBS ArcSafe® understands that each customer will have their own requirements when purchasing an RRS-1 and is more than happy to help customers decide on which options are right for them.

This section will list each option available for installation on the RRS-1 and briefly detail its features, components, and/or operation. For pricing or purchasing information about any of these options please contact CBS ArcSafe®.

- **Wired/Wireless Video System** – The wired/wireless video system allows the operator to monitor the remote racking operation using a provided camera and monitor. The camera may be either wired or wireless depending on the customer's requirements. The monitor is housed in a rugged hard case to prevent any damage. See Appendix F: Camera System for more information.
- **Radio Remote** – The radio remote option allows the user to operate and/or monitor the RRS-1's status wirelessly from extended distances. This option not only allows user to operate the RRS-1 remotely, but also allows them to view the RRS-1's operational status remotely, including a real time display showing instantaneous current draw from the CCM. See Appendix D: Wireless Pendant for more information.

- **Low Speed/Jog** – The low speed/jog package consists of a high torque/low speed gearbox as well as jog control for the RRS-1. The higher torque is helpful for remote racking of larger breakers and the jog functionality makes installing the RRS-1 on the switchgear much more simple. See Appendix B: Low Speed/Jog for more information.
- **High Lift** – Required for remote racking of any switchgear mechanism over 66" from the ground. This option allows personnel to reach the extremely high racking mechanisms that others cannot.
- **Stair Climber Rails** – The stair climber rails provide a low friction surface for use when transporting the RRS-1 up and down stairs. It also provides a level of protection to the control cabinet where all of the internal circuitry is housed. See Appendix H: Stair Climber Rails for more information.
- **LED Light** – This optional accessory provides a high intensity light source which attaches to the front of the RRS-1. This is useful for personnel operating the RRS-1 in low light environments. See Appendix E: LED Light for more information.
- **Power Slide** – The power slide system utilizes a motor to raise and lower the drive assembly and replaces the height adjustment handle provided with a standard RRS-1. This feature allows the operator to switch between racking heights of different models of breakers quickly and efficiently. See Appendix C: Power Slide for more information.
- **Wired Pendant Extension** – The wired pendant extension is an option which allows users to operate the RRS-1 from extended distances. In facilities which restrict radio remote transmission this is the best method for increasing operating distance.
- **Magne-blast Supervisory Link** – The CBS ArcSafe® Magne-blast Supervisory Link (MBSL) is designed to allow the RRS-1 to interface with the preexisting control circuit and cubicle mounted limit switches in General Electric (GE) Magne-blast AM-4.16 and AM-13.8 switchgear. See Appendix I: Magne-blast Supervisory Link for more information.
- **Pneumatic Tires** – The air filled pneumatic tires provide a cushioning effect and reduce wear on the RRS-1 unit during transport. Ideal for applications where transportation over uneven, rocky, or gravel surfaces is likely to occur. See Appendix G: Pneumatic Tires for more information.
- **Water Resistant Cover** – CBS ArcSafe® always recommends that the RRS-1 be stored in a dry, temperature controlled environment. However, because this is not possible for all users, CBS ArcSafe® offers a water resistant cover which protects the RRS-1 from contact with small amounts of liquid from above.
- **Various Interlock Defeats** – Many circuit breakers employ the use of mechanical or electrical interlocks during the racking procedure. Because users are not always able to operate these interlocks locally during remote operation, CBS ArcSafe® offers many different interlock defeats for the most popular applications. However, CBS ArcSafe® can custom design an interlock defeat system to fit any customer's needs.
- **Rear Impact Bar** – In tight conditions where the RRS-1 may contact other switchgear controls the use of the rear impact bar is recommended. The rear impact bar extends outward from the back of the RRS and provides the initial contact surface if the unit were to come in contact with anything behind it during operation. The bar is positioned several inches from the ground, which ensures that the rear impact bar contacts the switchgear, rather than the RRS-1 itself.

- **Casters** – In tight or constrained areas users may opt to add front wheel casters to the RRS-1. The front wheel castors allow for maximum mobility even in the tightest spaces, which simplifies installation and setup in these locations.
- **Transport Assist** – For applications which require frequent movement of the RRS-1 over flat and level surfaces, users may opt to add the Transport Assist to the RRS-1. The Transport Assist feature adds a set of extendable legs with locking wheels to the RRS-1 which the machine can be tilted onto, allowing easier movement over long distances. See Appendix J: Transport Assist for more information.

## Appendix B: Low Speed/Jog

RRS-1 units equipped with the Low Speed/Jog (LSJ) feature a lower speed/higher torque gear box when compared to a standard RRS-1, as well as the added functionality of being able to jog the RRS-1 drive motor. The low speed gearbox is able to provide more torque and therefore gives the RRS-1 the ability to rack larger breakers. This option may be required or recommended based on the application – a CBS ArcSafe® representative will help to make the determination. The jog control allows users to pulse the RRS-1 drive motor in either direction a set amount each time the jog button is pressed. These features come together as a package and may not be purchased separately. This section will detail the functionality and features of the LSJ option.

### B.1 Components

The LSJ option may be viewed as two separate features combined into one package, with each possessing its own components and instructions – this section will be broken down and explained as such. The low speed gearbox portion of the package will be covered first, followed by the jog control function.

#### B.1.1 Low Speed Gearbox

The low speed drive assembly (Shown in Figure B-1) is denoted by its red anodized spring loaded drive head (Compared with plain finish aluminum on standard RRS-1's). This drive assembly utilizes a higher ratio gearbox which provides more torque than that of the standard RRS-1. The gearbox itself is the same physical size as a standard gearbox; therefore differentiation between the two must come from the gear ratio shown on the placard fixed to the side of the gearbox. An RRS-1 equipped with a low speed gearbox will utilize the same drive motor as a standard RRS-1 unit.



**Figure B-1:** Low speed gearbox denoted by red anodized spring loaded drive head



## B.1.2 Jog Control

The jog control portion of the LSJ package allows operators to remotely jog the drive motor a specified amount each time the applicable button is depressed. The amount of motor rotation to be completed during the jog operation is adjustable and may be changed to suit the user's preferences or specific application. The wired pendant (and, if applicable, the radio remote) will have additional buttons to accommodate this added functionality when compared to their standard RRS-1 counterparts. The LSJ wired pendant is shown in the following figure.



**Figure B-2:** Wired pendant used for RRS-1 units equipped with LSJ

## B.2 Operation

RRS-1 units with LSJ installed will operate in the same manner as a standard unit when operating in automatic or manual mode using the standard “INSTALL” and “REMOVE” controls. However, RRS-1 units equipped with LSJ may also be operated in jog mode for either “INSTALL” or “REMOVE”.

### B.2.1 Wired Pendant Operation

Please follow these steps to operate the RRS-1 in the jog mode using the wired pendant.

1. First, ensure that the desired jog interval is set for the RRS-1. See section B.3 of this appendix for information regarding setting the jog interval.
2. The lower right-hand button on the wired pendant (See Figure B-2, labeled “JOG INSTALL”) will operate the drive assembly in the same direction as the standard “INSTALL” operation, but the motor will only rotate for the amount of time set by the Jog Interval (up to a maximum of approximately 1 revolution).
3. The lower left-hand button on the wired pendant (See Figure B-2, labeled “JOG REMOVE”) will operate the drive assembly in the same direction as the standard “INSTALL” operation, but the motor will only rotate for the amount of time set by the Jog Interval (up to a maximum of approximately 1 revolution).

### B.2.2 Wireless Pendant Operation

Please follow these steps to operate the RRS-1 in the jog mode using the wireless pendant.

1. First, ensure that the desired jog interval is set for the RRS-1. See section B.3 of this appendix for information regarding setting the jog interval.
2. Identify which style of wireless pendant is installed on the RRS-1. Please see Appendix D: Wireless Pendant, section D.1 regarding wireless pendant identification.
3. Power on the remote following the applicable power up instructions found in Appendix D: Wireless Pendant.
4. To perform a jog in the same direction as the standard “INSTALL” operation:
  - a. For the Standard Radio Remote, press the button labeled “JOG INSTALL” (See Figure B-3, left image; middle-right button labeled “JOG INSTALL”). The motor will only rotate for the amount of time set by the jog interval (up to a maximum of approximately 1 revolution).
  - b. For the CCM Radio Remote, press the button labeled “JOG IN” (See Figure B-3, right image; right-column button labeled “JOG IN”). The motor will only rotate for the amount of time set by the jog interval (up to a maximum of approximately 1 revolution).
5. To perform a jog in the same direction as the standard “REMOVE” operation:

- a. For the Standard Radio Remote, press the button labeled “JOG REMOVE” (See Figure B-3, left image; middle-left button labeled “JOG REMOVE”). The motor will only rotate for the amount of time set by the jog interval (up to a maximum of approximately 1 revolution).
- b. For the CCM Radio Remote, press the button labeled “JOG OUT” (See Figure B-3, right image; left-column button labeled “JOG OUT”). The motor will only rotate for the amount of time set by the jog interval (up to a maximum of approximately 1 revolution).



**Figure B-3:** Standard and CCM radio remotes equipped with jog function

### ***B.3 Setting the Jog Interval***

A feature of the LSJ system is the ability to set the length of the jog interval, or the length of time which the drive assembly rotates, when the applicable jog button is pressed. Changing this setting may be accomplished one of two ways depending on the firmware version present within the CCM on the RRS-1. See the following directions for setting the jog interval.

1. First, check the CCM firmware version currently being operated:

- a. For versions older than 3.0, the jog timer setting is not adjusted within the CCM interface. Please contact CBS ArcSafe® for more information on setting the jog interval on these units.
  - b. For version of firmware 3.0 and newer, the jog timer is adjusted within the CCM interface. The following steps will explain how to adjust these settings.
2. Follow steps 1-3 in section 3.1.6.2 and steps 1-5 in section 3.1.6.3 to arrive at the jog timer setup screen. The display should read "J.XX" (Where ".XX" is the current setting). The upper case "J" on the display tells the user that this is the jog timer setting. This setting may be set to any value between .01 and .75 seconds in .01 second increments by pressing the applicable "UP" or "DOWN" button.
  3. Once the desired setting has been input, press either the "INSTALL" or "REMOVE" button to return to the home screen.

## Appendix C: Power Slide

The power slide system utilizes an electric motor to raise and lower the drive assembly and replaces the height adjustment handle provided with a standard RRS-1. This feature allows the operator to switch between racking heights of different breaker models and positions quickly and efficiently. The power slide option is recommended for RRS-1 units which also have the high lift option installed, and can also be added to any existing unit as an upgrade regardless of other options currently installed. The standard height adjustment handle will still be shipped along with any RRS-1 unit which has the Power Slide option installed; however, rather than being installed on the unit, the handle will be placed in the storage bag in the event that the power slide system malfunctions or is damaged.

### C.1 Components

The power slide system includes a power slide motor to raise and lower the drive shaft motor and a control box on the RRS-1 that controls the height of the drive shaft motor. Both of these components can be seen in Figure C-1 below.



**Figure C-1:** Power slide components including the power slide control box and motor

#### C.1.1 Power Slide Motor

The power slide motor is located at the top of the height adjustment rail and replaces the height adjustment handle for performing raise and lower operations. The motor itself is a compact brushless DC motor capable of producing the required torque to raise and lower the RRS-1's drive assembly. The power slide motor is coupled to the height adjustment rail screw via a spider coupler setup. This spider coupler setup reduces shock and compensates for any minor misalignment in the system, producing very smooth raise and lower operations.

## C.1.2 Power Slide Control Box

The power slide control box is located on the upper height adjustment rail support arm. Users can change the drive assembly height by rotating the switch located on the front side of the motor control box to select the desired operation. The power slide motor's control/power cable exits the power slide control box and is routed to the motor using the height adjustment rail as a guide.

### ATTENTION!

Keep all body parts and RRS-1 moving parts clear of the power slide control/power cable which is routed from the power slide control box to the power slide motor. Any interference with this cable may damage it and render the power slide system useless. This cable may be routed in the open and held in place by padded clamps (On a standard RRS-1) or routed through a flexible cable track secured at both ends (On units with High Lift). Regardless of the configuration, it is very important to adhere to these guidelines.

## C.2 Power Slide Installation

For shipping purposes the power slide system will not be fully assembled when it arrives. The procedure to install the power slide is quite simple and requires only minimal tools. An image of the power slide as it will look when it arrives can be seen in Figure C-2. The required tools and the proper installation procedure are as follows.



**Figure C-2:** Power slide packaged for shipping

## C.2.1 Tools Required for Power Slide Installation

The following tools will be required to install the power slide to the RRS-1 once it is received:

- 8mm hex L-key
- 2mm hex key or 3/32" hex key

## C.2.2 Power Slide Installation And Alignment Procedure

The following procedure will instruct the user on how to properly install the power slide once it is received.

1. Please see section 2.2 titled "Unpacking the RRS-1" for instructions on how to properly unpack the unit.
2. Once the RRS-1 has been unpacked, the power slide components should look similar to Figure C-1 (Note, Figure C-1 shows an RRS-1 installed with power slide and high lift. The procedure will be the same for units without high lift installed as well.)
3. Carefully remove the shrink and bubble wrap which hold the power slide assembly to the height adjustment rail.
4. Next, located inside the storage bag of the RRS-1 should be a small plastic bag with the required hardware for power slide installation. Remove it and ensure all pieces are accounted for. Inside the bag should be the following components (Shown in Figure C-3 below):
  - a) [1] Flexible rubber spider shaft coupling
  - b) [1] Keyed shaft coupling hub
  - c) [2] M10 x 16 Socket head cap screws
  - d) [1] 4mm Key

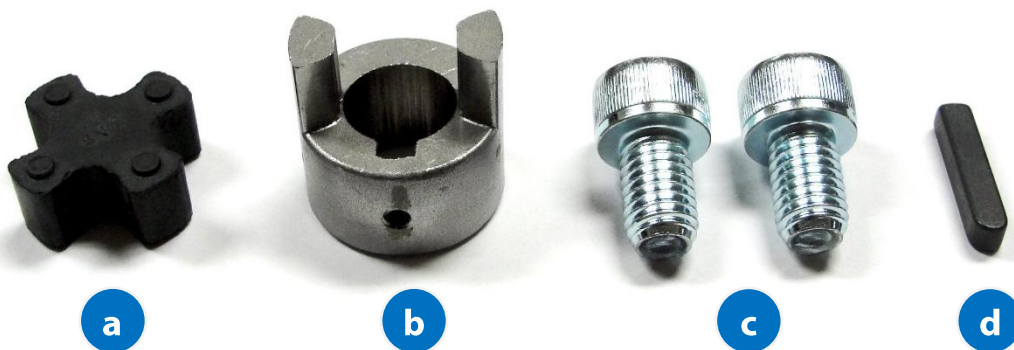

**Figure C-3:** Components required for power slide assembly

5. If all the hardware is present, the power slide assembly may now be installed. Start by first placing the flexible rubber spider shaft coupling into the corresponding shaft coupling hub currently mounted to the height adjustment rail screw.

6. Next, insert the 4mm key into the shaft of the power slide motor and install the keyed shaft coupling hub onto the motor shaft. Slide the keyed shaft coupling hub fully onto the motor shaft before continuing to the next step.
7. Now, place the power slide motor assembly on top of the height adjustment rail and align the motor shaft with the height adjustment rail screw. Slide the keyed shaft coupling hub down the motor shaft until it mates with the corresponding flexible rubber spider shaft coupling. Some manually rotation of either component may be necessary.
8. Once the coupling hubs of both the power slide motor shaft and the height adjustment rail screw are properly mated with the flexible rubber spider coupler and the power slide motor mount is resting on the top side of the height adjustment rail cap, tighten the set screw in the keyed shaft coupling hub for the power slide motor.

#### **NOTE:**

Depending on the age of the machine, it may require a 2mm hex key or a 3/32" hex key. Please make sure to use the correct size otherwise the set screw could become stripped and cause problems during future maintenance.

9. Lastly, fix the power slide motor mount to the height adjustment rail cap by installing the two M10 x 16 socket head cap screws using the 8mm hex L-key. These screws will thread through the corresponding slots on the power slide motor mount and into the corresponding holes on the top side of the height adjustment rail cap.
10. Run the power slide based on the operation instructions found in Section C.3 of this appendix and ensure that the rail does not "chatter" or operate erratically. These could be signs of misalignment of the power slide motor shaft to the height adjustment rail screw. To alleviate this problem loosen components, realign as necessary, retighten components, and test again. Repeat this process until successful.

## **C.3 Power Slide Operation**

The following steps will instruct users in the proper use of the power slide system.

1. First, ensure the main power disconnect on the RRS-1 is in the "ON" position and that the batteries are fully charged or the unit is operating on AC power.
2. Next, locate the power slide control box on the upper height adjustment rail support arm.
3. Turn the switch from the "OFF" or middle position to the applicable operation to be performed. Turn the switch CCW approximately 45° to "RAISE" the drive assembly, or approximately 45° CW to "LOWER" the drive assembly.
4. The switch will stay in the position the operator has selected until the operator turns the switch back to the middle or "OFF" position.



## ATTENTION!

Do not leave the power slide system running in either direction unattended. Failure to stop the motor before the drive assembly reaches full travel along the slide may cause the system to bind or get stuck at the end of its travel. If this occurs, users may have to manually jog the slide by hand in the opposite direction to free the system.

### C.4 Power Slide Troubleshooting

In order to properly troubleshoot the power slide system please ensure that the RRS-1 is fully charged or plugged into to AC power prior to beginning.

#### C.4.1 Power Slide Basic Troubleshooting Procedures

This section will detail basic troubleshooting procedures users may perform to repair a non-working power slide system. Please read this list and carefully go through each step prior to contacting CBS ArcSafe®.

Issue	Cause	Solution
Power slide motor will not rotate when the RAISE/LOWER switch is operated	RRS-1 main disconnect is in the "OFF" position	Power on the RRS-1 by turning the main disconnect to the "ON" position
	RRS-1 is powered "ON" but "E-Stop" on pendant(s) is engaged	Reset "E-Stop" on applicable pendant(s)
	RRS-1 is powered "ON" but battery power is low	Plug the RRS-1 into AC power to power the unit and charge the batteries
	Drive assembly is stuck at one of the extents of travel	Manually rotate either the coupler assembly or height adjustment rail screw in the opposite direction of the jam to free the motor
Power slide motor will rotate when the RAISE/LOWER switch is operated, but the drive assembly will not move	Fastener or key has become loose or lost in coupler assembly	Check for missing or loose set screw and/or key in upper shaft coupling hub. Check for missing or broken roll pin in lower shaft coupling hub. Retighten or replace as necessary.
	Drive assembly threaded slide bearing is stripped out (Drive assembly is able to move freely up and down independent of height adjustment rail)	Contact CBS ArcSafe® for replacement threaded slide bearing and replacement procedure
Power slide motor will rotate when the RAISE/LOWER switch is operated, but the drive assembly makes noise as it travels	The power slide motor is misaligned with the coupling and/or height adjustment rail screw	See section C.2.2 for procedure detailing proper alignment techniques for power slide system components

## C.4.2 Power Slide Advanced Troubleshooting Procedures

To perform advanced power slide troubleshooting procedures users must carefully remove the cover from the power slide control box mounted to the RRS-1 frame. Remove the four screws holding the cover in place to expose the internal wiring of the power slide control box. Users are assumed to have already performed the steps in Section C.4.1 before continuing onto this section.

Issue	Cause	Solution
LED on power slide driver board does not illuminate when RAISE/LOWER switch is operated	The power slide driver board is not receiving power	Check to ensure all plugs and connections in power slide control box are tight. Tighten or fix any loose plugs or connections.
		Check connection between power slide motor and power cable coming from the power slide control box
LED on power slide driver board flashes a certain number of times when RAISE/LOWER switch is operated	Two flashes of LED – Overload: The motor is stuck at one of the extents of travel	Manually rotate either the coupler assembly or height adjustment rail screw in the opposite direction of the jam
	Two flashes of LED – Overload: RAISE/LOWER direction was switched too quickly	Power off the RRS-1 to reset the power slide driver board
	Three flashes of LED – Sensor Error: Bad connection between power slide motor and power slide driver board	Check to ensure all plugs and connections in power slide control box are tight. Tighten or fix any loose plugs or connections. Check connection between power slide motor and power cable coming from the power slide control box
	Four flashes of LED – Overvoltage: The RRS-1 power system is malfunctioning and outputting more than 24VDC	Power off the RRS-1 and contact CBS ArcSafe®.
	Five flashes of LED – Insufficient Voltage: The RRS-1 power system is not providing enough voltage to operate power slide motor	Plug the RRS-1 into AC power to power the unit and charge the batteries
	Six flashes of LED – Overspeed Error: The power slide motor has rotated faster than allowed	Power off the RRS-1 and contact CBS ArcSafe®
LED on power slide driver board remains illuminated when RAISE/LOWER switch is operated	Speed potentiometer is not set correctly	Turn the small yellow dial of the speed potentiometer on the power slide driver board fully clockwise to adjust the speed to the correct setting

# Appendix D: Wireless Pendant

The wireless pendant station option (Also known as the radio remote) consists of a portable, handheld transmitter/transceiver and a base unit receiver/transceiver mounted to the RRS-1. This option is ideal for users who have extended operation distance requirements or space restrictions which would prevent corded operation.

## D.1 Wireless Pendant Station Identification

CBS ArcSafe® offers two styles of wireless pendant stations to customers, depending on their specific needs. The standard radio remote offers users the ability to remotely operate all breaker racking functions via the handheld unit, while the CCM radio remote includes several more features, including a display screen for reading instantaneous current from the CCM, and control of other machine features as well.

For more information regarding the components, configuration, and operation for the Standard Radio Remote see Section D.2. For more information regarding the components, configuration, and operation for the CCM Radio Remote see Section D.3.

## D.2 Standard Radio Remote

This section will describe to the user the components, configuration, and operation of the standard radio remote for the RRS-1.

### D.2.1 Standard Radio Remote Introduction

The CBS ArcSafe® RRS-1 remote racking system may be equipped with the ability to remotely operate the unit via a wireless pendant station. This option gives users the capability to operate the unit wirelessly, while also moving them further outside of the arc flash boundary than a standard wired pendant will allow. In many cases where confined spaces are a contributing factor to the inherent dangers involved, the radio remote option provides a safe and convenient solution for placing personnel outside of the arc flash boundary. The radio remote option is available for all RRS-1 units regardless of other options installed from the factory.

### D.2.2 Standard Radio Remote Components

The CBS ArcSafe® RRS-1 standard radio remote pendant station is made up of two main components: the handheld transmitter and the base unit receiver. The pair works together to control the RRS-1 based on the user's commands. This section will describe each component in more detail and list the main technical specifications of each.

### D.2.2.1 Handheld Transmitter

The handheld radio remote is the device that the user will interact with when operating the RRS-1 remotely. This device has been designed to give the user the same functionality as the wired pendant, but instead allowing the operator to perform these functions wirelessly.

#### Technical Specifications

<b>Frequency</b>	...	428-438 MHz
<b>Operating Distance</b>	...	500'
<b>Weight</b>	...	11 oz.
<b>Dimensions</b>	...	7.25" x 2.4" x 2"
<b>Power Source</b>	...	(2) AA Batteries
<b>Operating Temp</b>	...	-31 to 167 °F
<b>Button Life</b>	...	2 Million Operations

**Table D-1:** Handheld Transmitter Specifications



**Figure D-1:** Standard radio remote handheld transmitter

#### ATTENTION!

The wireless pendant station is designed specifically for the system that it came with. The radio remote will NOT work with any other CBS ArcSafe® system. Therefore please keep the radio remote with the system that it came with.

### D.2.2.2 Base Unit Receiver

The base unit receiver receives the wireless signals from the handheld transmitter needed to control the RRS-1. The base unit receiver is attached to the RRS-1, and although it is quite sturdy, care must be taken to ensure that during transportation the remote receiver is not damaged.

#### Technical Specifications

<b>Frequency</b>	...	428-438 MHz
<b>Operating Distance</b>	...	500'
<b>Dimensions</b>	...	10" x 6.5" x 4.5"
<b>Power Source</b>	...	24 VDC
<b>Operating Temp</b>	...	-31 to 167 deg F

**Table D-2:** Base Unit Receiver Specifications



**Figure D-2:** Standard radio remote base unit receiver

## D.2.3 Standard Radio Remote Buttons – Layout & Description

The standard radio remote has six control buttons available to perform various functions related to the remote operation of the RRS-1 unit, depending on the options installed. This section will describe all button layouts and the functionality of each in detail.

### D.2.3.1 Standard Radio Remote Button Layouts



**Figure D-3:** Standard radio remote button layouts and descriptions

### D.2.3.2 Standard Radio Remote Button Descriptions

- **Install** – The upper right-hand button on the standard radio remote (Seen in Figure D-3 and labeled “INSTALL”) will operate the drive assembly in the install direction (See section 3.1.6.2 for information regarding setting the motor direction). The RRS-1 will operate in this direction based on the settings input into the current control monitor at the time of operation.
- **Remove** – The upper left-hand button on the standard radio remote (Seen in Figure D-3 and labeled “REMOVE”) will operate the drive assembly in the remove direction (See section 3.1.6.2 for information regarding setting the motor direction). The RRS-1 will operate in this direction based on the settings input into the current control monitor at the time of operation.
- **Jog Install** – The middle right-hand button on the standard radio remote (Seen in Figure D-3 and labeled “JOG INSTALL”) will operate the drive assembly in the same direction as the standard “INSTALL” operation. When the “JOG INSTALL” button is pressed and held, the RRS-1 drive assembly will rotate up to a maximum of approximately 1 revolution (Depending on the value which is set for the jog interval). See Appendix B: Low Speed/Jog, section B.3 for information regarding setting the jog interval.

- **Jog Remove** – The middle left-hand button on the standard radio remote (Seen in Figure D-3 and labeled “JOG REMOVE”) will operate the drive assembly in the same direction as the standard “REMOVE” operation. When the “JOG REMOVE” button is pressed and held, the RRS-1 drive assembly will rotate up to a maximum of approximately 1 revolution (Depending on the value which is set for the jog interval). See Appendix B: Low Speed/Jog, section B.3 for information regarding setting the jog interval.
- **Reset** – The lower right-hand button on the standard radio remote (Seen in Figure D-3 and labeled “RESET”) will reset the CCM Status Indicator for RRS-1 units equipped with this feature and having CCM firmware versions prior to “v3.0”.

## D.2.4 Standard Radio Remote Operation

This section will describe how to setup and operate the RRS-1 via the standard radio remote.

### NOTE:

This setup and operation procedure pertains only to setting up and operating the RRS-1 with the standard radio remote. Prior to remote operation, please read and follow all steps outlined in sections 2 and 3 which detail in depth the preparation and setup of the RRS-1 prior to remote operation. Before beginning, please ensure that all applicable steps have been taken prior to performing the remote racking procedure.

1. First, ensure the main power switch on the RRS-1 is in the “ON” position and that the batteries are fully charged or the unit is operating on AC power.
2. Ensure that the “RADIO/PENDANT” selector switch located on the top side of the RRS-1 control cabinet is switched to the “RADIO” position.
3. Next, inspect the handheld transmitter and ensure that the RED “E-Stop” button is released. If it is not, turn it clockwise to release it.
4. Rotate the green switch in the upper right-hand corner from “OFF” to the “ON” position.
5. Lastly, press the GREEN “START” button in the lower left-hand corner to power up the remote. At this point, the display on the CCM of the RRS-1 should also power on and read “vX.X” (Where “X.X” is the current firmware version installed on the CCM).
6. The CCM display on the RRS-1 should now read “0.0”.
7. Use the buttons (Described in section D.2.3 of this appendix) on the handheld transmitter to execute the applicable action to be performed.
8. If the user wants to stop operation for any reason during use they may press the RED “E-Stop” button or turn the green switch in the upper right-hand corner to the “OFF” position.
9. After operation, to power down the standard radio remote turn the green switch in the upper right-hand corner to the “OFF” position.

## **D.3 CCM Radio Remote**

This section will describe to the user the setup, operation, and functionality of the CCM radio remote for the RRS-1. This upgrade is ideal for situations involving long distance requirements or restrictions for safe removal or insertion of the equipment.

### **D.3.1 CCM Radio Remote Introduction**

The CBS ArcSafe® RRS-1 remote racking system may be equipped with the ability to remotely operate the unit via a radio remote pendant station. This upgrade gives users the capability to operate the unit wirelessly, while at the same time moving them further beyond the arc flash boundary than a standard corded pendant will allow. In many cases where confined spaces are a contributing factor to the inherent dangers involved, the radio remote option provides a safe and convenient solution for placing personnel outside of the arc flash boundary. The radio remote option is available for all RRS-1 units regardless of other options installed from the factory. This section will explain all of the features and operational aspects of the CCM radio remote option.

#### **D.3.1.1 Improved Radio Remote Functionality**

The CCM Radio Remote feature consists of several key advancements over prior models including but not limited to:

- Ability to constantly monitor RRS-1 current reading via a display screen
- Wireless control of key machine features
- Seamless integration with upgraded Current Control Monitor
- Compatible with all control voltages of GE Magne-blast (Supervisory link required. See Appendix I: Magne-blast Supervisory Link for more information)
- Capable of withstanding radio interference in congested environments

In addition to the features listed above, the improved handheld radio remote features a two line LCD display that can alert users of machine and operational status. The display is equipped with backlight and contrast adjustment capability which allows users to operate in any lighting conditions. This feature also allows users to maximize handheld radio remote battery life by limiting backlight power.

The remote itself is constructed from a very strong, high impact plastic that will withstand the harsh environments that these units encounter. The clear polycarbonate lens over the display and a stainless steel faceplate provide a tough exterior to ensure long handheld radio remote life. LED indicating lights below the display screen correspond with the LED beacon on the RRS-1 current control status indicator. Extra large buttons provide a tactile response when operated even with heavy gloves.

The radio remote pendant station also boasts a 300 foot line-of-sight operational boundary (Operational boundary will vary with environment due to size and number of obstructions preventing line-of-sight



operation). Should the user move out of range of the receiver base unit the handheld radio remote's display will read "NO SIGNAL", alerting the user to move back within operational range. The 2.4 GHz radio frequency used in this application utilizes Direct Sequence Spread Spectrum (DSSS) technology. This feature allows the radio remote option to be used in even the most congested radio environments without interference.

The following sections will describe in more detail each of the components of the radio remote pendant station and their technical specifications, button and display information for the handheld radio remote, setup and operation of the radio remote pendant station, as well as basic troubleshooting tips.

### **D.3.2 CCM Radio Remote Components**

The CBS ArcSafe® RRS-1 CCM radio remote pendant station is made up of two main components: the handheld radio remote and the receiver base unit. This pair works in unison to control the RRS-1 based on the user's commands as well as allow the user to monitor machine and operational status. This section will describe each component in more detail and list the main technical specifications of each.

### D.3.2.1 Handheld Transceiver

The handheld transceiver is the device that the user will interact with when operating the RRS-1 remotely. This device has been designed to give the user even more functionality than the corded pendant can provide by monitoring machine feedback as well as enabling the user to control various other machine functions from the remote. The radio frequency technology used by this system does not designate a specific channel number, instead it allows for sharing of a single frequency band among multiple users in the same facility with no crossover in signal. This technology makes the radio remote pendant station very resistant to interferences from all sources.

#### Technical Specifications

<b>Frequency</b>	...	2.4 GHz DSSS*
<b>RF Power</b>	...	2 mW
<b>Weight</b>	...	15.2 oz
<b>Dimensions</b>	...	9.1" x 3.1" x 1.25"
<b>Power Source</b>	...	(4) AA Batteries
<b>Operating Temp</b>	...	-4°F to 130°F
<b>Button Life</b>	...	5 Million Operations
<b>Screen Size</b>	...	1.5" X 0.64"

**Table D-3:** Handheld transceiver specifications



**Figure D-4:** CCM radio remote handheld transceiver

#### ATTENTION!

The handheld radio remote is designed specifically for the system that it came with. The radio remote will NOT work with any other CBS ArcSafe® system, therefore please keep the radio remote with applicable system.

### D.3.2.2 Base Unit Transceiver

The receiver base unit is the device located on the right side of the RRS-1 frame. This unit communicates with the handheld radio remote via the 2.4 GHz frequency. The receiver base unit is equipped with five diagnostic LED outputs which allow the user to visually verify radio connection between the receiver base unit and the handheld radio remote. The receiver base unit has been certified as vibration and shock resistant per IEC standard IEC60068-2-6.

#### Technical Specifications

<b>Frequency</b>	...	2.4 GHz DSSS*		
<b>Antenna</b>	...	Internal		
<b>Dimensions</b>	...	5.24" x 4.69" x 1.42"		
<b>Construction Material</b>	...	High Impact Polymer		
<b>Operating Temp</b>	...	-4°F to 150°F		
<b>Diagnostic Indicator LED Outputs</b>	...	<i>In</i>	Green	- Input On
		<i>Out</i>	Green	- Output On
		<i>Health</i>	Green	- Pulse/Sec OK
		<i>TX/RX</i>	Green	- Receive
			Red	- Transmit
		<i>Power</i>	Yellow	- OK
	Red/Green		- Fault	

**Table D-4:** Base unit transceiver specifications



**Figure D-5:** CCM radio remote base unit transceiver

### D.3.3 CCM Radio Remote Buttons & Display – Layout & Description

The CBS ArcSafe® RRS-1 handheld radio remote is capable of performing most functions on the unit remotely from the palm of the user's hand. The large backlit display allows the user to monitor machine operational status in real time and signals the user when the machine has completed the racking procedure. This section will describe the functions of the buttons located on the remote as well as all display characters and their meanings. The figure in the section on the following page illustrates the functions of the radio remote.

#### D.3.3.1 CCM Radio Remote Button & Display Layout



- |                               |                                      |                               |
|-------------------------------|--------------------------------------|-------------------------------|
| 1. Display Line 1             | 8. Jog Auxiliary "B" Button          | 15. Auxiliary "A" In Button   |
| 2. All Stop Button            | 9. Start Auxiliary "C" Button        | 16. Stop Auxiliary "B" Button |
| 3. Power On Button            | 10. Display Line 2                   | 17. Stop Auxiliary "C" Button |
| 4. Remove Button              | 11. Current Control Status Indicator | 18. Jog Auxiliary "C" Button  |
| 5. Jog Remove Button          | 12. Power Off Button                 |                               |
| 6. Auxiliary "A" Out Button   | 13. Install Button                   |                               |
| 7. Start Auxiliary "B" Button | 14. Jog Install Button               |                               |

Figure D-6: CCM radio remote handheld transceiver functions







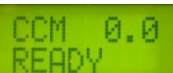

### **D.3.3.2 CCM Radio Remote Button & Display Descriptions**

This section will describe in detail the functionality of each item listed in Figure D-6 of the previous section.

1. **Display Line One ( Figure D-6.1 )** – When running in CCM mode, this line will display the instantaneous current draw of the motor during automatic operation. When performing other functions, this line will display information related to the action being performed.
2. **All Stop Button ( Figure D-6.2 )** – This button will allow the user to stop all actions being performed. Pressing this button during CCM operation will stop the machine and cut power to the CCM on the RRS-1. Once this button is pressed all other button activity is ceased until the green “ON” button is pressed again and Display Line Two reads “READY”.
3. **Power On Button ( Figure D-6.3 )** – Once the RRS-1 power has been turned on and the selector switch on top of the control cabinet has been set to “RADIO”, press this button to establish link between the RRS-1 and the handheld radio remote. This button will also allow the user to resume operation after an “ALL STOP” command has been issued.
4. **Remove Button ( Figure D-6.4 )** – Pressing this button will operate the RRS-1 in CCM mode based on the settings input on the current control monitor. The RRS-1 will not shut down until an over-current has been detected by the current control monitor, indicating the end of travel has been reached. To shut off operation prior to the CCM sensing end of travel, press either the “ALL STOP” button or “INSTALL” button.
5. **Jog Remove Button ( Figure D-6.5 )** – This command will jog the motor in the remove direction for the amount of time set in the current control monitor.
6. **Auxiliary “A” Out Button ( Figure D-6.6 )** – This function is used when additional functionality is necessary for remote racking operations. Usage of this button will be explained in any included tooling guides, if applicable.
7. **Start Auxiliary “B” Button ( Figure D-6.7 )** – This button starts an auxiliary function of the RRS-1 such as a videos camera or LED light. See the appropriate appendix for information on a specific option or accessory.
8. **Jog Auxiliary “B” Button ( Figure D-6.8 )** – This button operates an auxiliary function of the RRS-1 momentarily such as a video camera or LED light. See the appropriate appendix for information on a specific option or accessory.
9. **Start Auxiliary “C” Button ( Figure D-6.9 )** – This button starts an auxiliary function of the RRS-1 such as a video camera or LED light. See the appropriate appendix for information on a specific option or accessory.
10. **Display Line Two ( Figure D-6.10 )** – Prior to running the machine in CCM mode, this line will display the machine’s operational status and during CCM operation this line will remain blank. During other operations, this line will provide information relating to the action being performed.

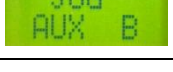
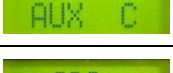
11. **Current Control Status Indicator LEDs ( Figure D-6.11 )** – These LEDs perform the same function as the LED beacon on the RRS-1 and will mimic its actions at all times. Please see Section 3.1.5 “CCM Status Indicator” of this manual to learn more about the functions of these lights.
12. **Power Off Button ( Figure D-6.12 )** – To disconnect the link between the RRS-1 and the handheld radio remote press and hold this button for 10 seconds. The display will read “TURNING OFF” once this happens and will then shut down power.
13. **Install Button ( Figure D-6.13 )** – Pressing this button will operate the RRS-1 in CCM mode based on the settings input on the current control monitor. The RRS-1 will not shut down until an over-current has been detected by the current control monitor, indicating the end of travel has been reached. To shut off operation prior to the CCM sensing end of travel, press either the “ALL STOP” button or “REMOVE” button.
14. **Jog Install Button ( Figure D-6.14 )** – This command will jog the motor in the install direction for the amount of time set in the current control monitor.
15. **Auxiliary “A” In Button ( Figure D-6.15 )** – This function is used when additional functionality is necessary for remote racking operations. Usage of this button will be explained in any included tooling guides, if applicable.
16. **Stop Auxiliary “B” Button ( Figure D-6.16 )** – This button stops an auxiliary function of the RRS-1 such as a video camera or LED light. See the appropriate appendix for information on a specific option or accessory.
17. **Stop Auxiliary “C” Button ( Figure D-6.17 )** – This button stops an auxiliary function of the RRS-1 such as a video camera or LED light. See the appropriate appendix for information on a specific option or accessory.
18. **Jog Auxiliary “C” Button ( Figure D-6.18 )** – This button operates an auxiliary function of the RRS-1 momentarily such as a video camera or LED light. See the appropriate appendix for information on a specific option or accessory.

### D.3.3.3 CCM Radio Remote Display Descriptions

Display Screen	Meaning
	Opening screen when the handheld radio remote is activated.
	Following the opening screen this screen will appear on startup. Will also appear after an "ALL STOP" command is given.
	This screen will appear when the unit is ready to perform an operation.
	When pressing the "INSTALL" button this screen will appear.
	When pressing the "REMOVE" button this screen will appear.
	During CCM operation this screen will monitor the current draw of the motor.
	Once an over-current has been detected this screen will alert the user. Pressing any button on the remote will clear this screen.
	This screen will appear when "AUX A IN" button is pressed.
	This screen will appear when "AUX A OUT" is pressed.
	This screen will signal to the user that auxiliary function "B" has been started.
	During momentary operation of auxiliary "B" this screen will display.
	This screen will signal to the user that the auxiliary function "B" has been stopped.
	This screen will signal to the user that the auxiliary function "C" has been started.
	During momentary operation of auxiliary function "C" this screen will appear.
	This screen will signal to the user that the auxiliary function "C" has been stopped.
	After holding the "OFF" button for 10 seconds this screen will alert the user that the remote is turning off.

**Table D-5:** CCM radio remote display descriptions

### D.3.4 CCM Radio Remote Operation

This section will describe how to setup and operate the RRS-1 via the CCM radio remote.

#### NOTE:

This setup and operation procedure pertains only to setting up and operating the RRS-1 with the CCM radio remote. Prior to remote operation, please read and follow all steps outlined in sections 2 and 3 which detail in depth the preparation and setup of the RRS-1 prior to remote operation. Before beginning, please ensure that all applicable steps have been taken prior to performing the remote racking procedure.

1. First, ensure the main power switch on the RRS-1 is in the "ON" position and that the batteries are fully charged or the unit is operating on AC power.
2. Ensure that the "Radio/Pendant" selector switch located on the top side of the RRS-1 control cabinet is switched to the "RADIO" position.
3. Next, take the handheld transmitter and press and hold the green "ON" button until the display reads "CBS ARCSAFE". At this point, the display on the CCM on the RRS-1 should also power on and read "vX.X" (Where "X.X" is the current firmware version installed on the CCM).
4. Once handheld receiver and the base unit receiver have linked up, the CCM on the RRS-1 should read "0.0". The display on the handheld transmitter may read one of two ways depending on the firmware version present. If the display reads "CCM 0.0, READY", please proceed to step 5. If the display reads "CCM 0.0, ALL STOP", please see below.
  - To remove the "ALL STOP" order and begin a remote operation press the green "ON" button once more until the display on the handheld radio remote reads "CCM 0.0, READY".
5. To perform an automatic remote racking operation, press the applicable "INSTALL" or "REMOVE" button.
6. Once the unit senses an over-current condition it will shut down operation automatically and alert the user via the CCM Status Indicator and the handheld transmitter's display. The handheld transmitter display should read "STOP CCM, STOP CCM" after an over-current stop signal is received.
  - To clear the "STOP CCM, STOP CCM" screen, press any button on the remote to return to the "CCM 0.0, READY" screen.
7. If the user wants to stop the operation prior to an over-current condition they can press the "ALL STOP" button or the button corresponding to the opposite operation.
  - If an "ALL STOP" command was given, the user must clear the all stop screen by pressing the green "ON" button.



8. To jog the unit, press the applicable direction jog button. The length of the jog time can be set on the CCM on the RRS-1, please see Appendix B: entitled “Low Speed/Jog” for more information on setting the jog timer.
9. To start operation of an auxiliary function via the handheld radio remote press the applicable button corresponding to that operation. To stop operation of the auxiliary function press the applicable stop button. To operate the auxiliary function momentarily, press the applicable jog button.
10. To power down the CCM radio remote press and hold the red power off button for approximately 10 seconds. After this time, the display should read “TURNING OFF” and approximately 10 seconds later the display will go blank. The CCM radio remote is now turned off.

### **D.3.5 Troubleshooting Guide**

Occasionally, the CCM radio remote will not function properly and users may have to troubleshoot. Users are encouraged to contact CBS ArcSafe® if this happens in order to talk with a trained professional regarding the issue.

#### **D.3.5.1 CCM Radio Remote Resynchronization**

In rare instances, the handheld CCM Radio Remote transceiver may lose its communication link to the base unit transceiver located on the RRS-1. If this communication link is lost, the handheld transceiver will not operate the RRS-1 in any way. The procedure to re-establish this connection is very simple and can be performed by anyone familiar with the unit. If the CCM radio remote link must be resynchronized with the RRS-1 frequently, contact CBS ArcSafe® for more advanced troubleshooting information.

Follow these steps to re-establish the communication link between the handheld transceiver and the base unit transceiver.

1. First, ensure that the remote that is malfunctioning belongs to the RRS-1 in question. If there are multiple RRS-1's equipped with the CCM Radio Remote in the area, check to ensure that the handheld transceivers have not been mismatched.
2. Next, power on the RRS-1 and switch the “RADIO/PENDANT” switch to the radio setting. Inspect the lights on the exterior of the base unit transceiver located on the right side of the RRS-1. There are five indicating lights each labeled with its function on the transceiver. Find the light labeled “HEALTH” and watch it closely. If the light is blinking green, the unit is in working condition and the user may proceed. If the light is doing anything other than blinking green, this is a sign of a more serious problem. Users should power down the unit and contact CBS ArcSafe® for more information.
3. After the “HEALTH” light has been checked and verified, power down the RRS-1. Next, also turn off the handheld unit by holding down the red “OFF” button in the upper right corner of the

keypad. The display will read "TURNING OFF" for approximately 10 seconds. When the display has gone blank the handheld unit is off.

4. After both the RRS-1 and the handheld transceiver have been powered off, remove the power cable from the base unit by unplugging the GRAY plug from the bottom side of the unit.
5. Next, with the "RADIO/PENDANT" switch still switched to "PENDANT", power the RRS-1 back on. With the handheld unit in hand, ensure there is a clean and unobstructed line of sight between the handheld unit and the base unit.
6. Now, press and hold the green "ON" button located in the upper left corner of the keypad while at the same time pressing and holding the "ALL STOP" button located at the top center of the keypad. Both buttons must be held simultaneously.
7. The display will go through its initialization screens for approximately 10 seconds. When the display reads "ASSOC ACTIVE", immediately release both the "ON" and "ALL STOP" buttons at the same time.
8. After releasing both buttons there is a two second window to press and hold the "START AUX C" button. If this time window is missed, the user must start this entire procedure over from Step 2.
9. Continue holding the "START AUX C" button until the display reads "POWER UP BASE". Once this has happened the user may release the button.
10. Users now have approximately 25 seconds to plug in the GRAY plug on the bottom of the base unit.
11. If the power cable has been reconnected within the time window, the display on the handheld unit will read "ASSOC SUCCESS". If the display does not read "ASSOC SUCCESS" the operation was not done within the time window; please restart this procedure from Step 2. If the display reads "LINK FAILED" there is a more serious problem that must be examined further. If this is the case please contact CBS ArcSafe®.
12. If everything was done properly, the RRS-1 should now be ready to operate using the handheld CCM Radio Remote.

### ***D.3.5.2 CCM Radio Internal Options***

The CCM radio remote has several features that the user may wish to adjust to maximize usability. These include backlight intensity, contrast, and battery voltage monitor. This section will educate users on how to adjust these features.

1. First, ensure that the RRS-1 main disconnect is in the OFF position. This procedure will only focus on the wireless pendant itself.
2. With the RRS-1 main disconnect powered off, press and hold the green "Power On" button in the upper left hand corner. This button must remain pressed throughout the entirety of this procedure.

3. While pressing the "Power On" button, the display should read in order of occurrence; "CBS ArcSafe", "No Signal" and finally "Setup". Once the display reads "Setup" the user may begin altering the settings of the remote.

**NOTE:**

Users not wishing to adjust contrast or backlighting parameters may skip to step 6 as steps 4-5 are not necessary to access the other features.

4. With the display reading "Setup" and the user still depressing the "Power On" button, the contrast may be adjusted.
  - a. To increase contrast, hold down the "Stop Aux B" button while holding down the power button. The user should notice the screen contrast increase.
  - b. To decrease the contrast, hold down the "Stop Aux C" button while holding down the power button. The user should notice the screen contrast decrease.
5. Next, the user may adjust the backlighting settings. With the "Power On" button still being depressed, users may perform one of the following:
  - a. Press the button labeled "Aux A Out" to always enable backlighting
  - b. Press the button labeled "Start Aux B" to enable the backlight for a period of time.
  - c. Press the button labeled "Start Aux C" to disable the backlight altogether.
6. Next, users may scroll through the available other parameters of the remote. While still holding the "Power On" button, press and release the "All Stop" button. The display should change from "Setup" to a battery monitor.
7. Pressing the "All Stop" button several more times will scroll users through various screens displaying MSGS/SEC, Channel, Handh ID, Base ID, and Firmware Version. Users should not adjust these parameters as they are essential to CCM radio remote operation.
8. Pressing the "All Stop" button once more reveals a screen which displays "Timeout". This is the length of inactivity before the remote is allowed to shut down.
  - a. To increase this time press the button labeled "Jog In".
  - b. To decrease this time, press the button labeled "Aux A In"
9. To end the setup at any time, release the green "Power On" button on the CCM radio remote.

## Appendix E: LED Light

This section will detail the components which make up the LED Light system as well as the steps required for operation.

### E.1 Components

The LED light system consists of an LED light mounted to the tether bracket above the drive assembly of the RRS-1. The LED light is mounted via an adjustable base and can pan up and down approximately 30° as well as rotate 360°. The camera is hard-wired to the control cabinet via the auxiliary component coil cord which is mounted to the drive assembly on the backside of the motor near the brake. The mounted LED light is shown highlighted in the following image:



**Figure E-1:** LED Light installed on RRS-1

### E.2 Operation

The following procedure will demonstrate how to operate the LED light.

1. First, ensure the main power disconnect on the RRS-1 is in the "ON" position and that the batteries are fully charged or the unit is operating on AC power.
2. Next, locate the switch labeled "LIGHT" on the top side of the control cabinet.
3. Turn the switch from the "OFF" position to the "ON" position. The LED light should illuminate.
4. To turn off the light, turn the switch to the "OFF" position.

## Appendix F: Camera System

The wired/wireless video system allows the operator to monitor the remote racking operation using a provided camera and monitor. The camera may be either wired or wireless depending on the customer's requirements. The monitor is housed in a rugged hard case to prevent any damage.



**Figure F-1:** Camera System Monitor

### ***F.1 Wireless Camera System***

The wireless camera system allows the customer to remotely monitor a racking operation, without any wired connections to the RRS-1.

## F.1.1 Components

1. **Wireless Camera** – The wireless camera can be configured three ways – mounted directly to and powered by the RRS-1; provided with a flexible magnetic base with integrated power supply; or provided with a fixed magnetic mount for installation anywhere and powered by a remote power supply.
2. **Monitor and Receiver Case** – The water resistant monitor and receiver case houses the wireless video receiver, LCD display, power cable, and internal battery pack. It communicates wirelessly with the camera to provide the video display.
3. **Wireless Video Receiver** – The wireless video receiver is housed inside of the monitor and receiver case. It has multiple channels to combat wireless interference.
4. **LCD Display** – The LCD display is mounted inside of the monitor and receiver case and folds flat for storage. This monitor has two inputs to allow the user to switch between two camera feeds.
5. **Power Cable** – The power cable charges the internal battery pack and powers the unit if AC power is available.
6. **Internal Battery Pack** – The internal battery pack inside the monitor and receiver case powers both the LCD monitor and the wireless receiver. It allows the unit to run up to 5 hours on a single charge.

## F.1.2 Setup and Operation

The video camera component of the wireless camera system may be either fix-mounted on a remote racking system or provided with a magnetic mount for remote placement almost anywhere. Users may choose to utilize one or both of these systems to assist with the remote racking procedure. Each CBS ArcSafe® wireless camera system is capable of switching between two camera feeds, allowing users to utilize both camera styles and view the output in one location. This section will focus on the setup and operation of each system.

### ATTENTION!

The maximum rated reception distance (line of sight) for the wireless camera system is 300 ft; however, any obstructions between the camera and the receiver may cause interference and distort the wireless signal.

### F.1.2.1 Wireless Camera System Hardwired To RRS-1

This section will detail the setup and operation of the wireless video system for cameras fix-mounted to the RRS-1. For magnetic camera systems please see the next section.

1. Power on the RRS-1 using the main power disconnect located on the control cabinet. This will power up all systems, including the wireless camera, and allow them to be operated.
2. Once main power on has been turned on and the unit is either charged and running on internal batteries or utilizing AC power, the switch labeled “CAMERA” must be turned to the “ON” position. See the Figure F-2 showing a standard switch layout.

**NOTE:**

Depending on model and options installed, switches may be in a different location than pictured.



**Figure F-2:** Standard switch layout showing “CAMERA” switch in the “OFF” position

3. With the camera switch in the “ON” position, the fix mounted camera is now powered on and transmitting a video signal wirelessly to the receiver located in the monitor and receiver case.
4. Open the monitor and receiver case and power on the system by turning the green power switch clockwise. A light within the switch will illuminate to signal the user that the unit is powered on. The initial charge was performed by CBS ArcSafe®; all subsequent charges are performed by plugging the LCD power cable into AC power. Please ensure that the internal batteries are charged or that the unit is plugged into AC power before operation.



**Figure F-3:** Monitor and receiver case interior

5. Next, power on the monitor using the power button located on the bottom right side of monitor.
6. If multiple inputs are being utilized, such as a magnetic and fix mounted camera, the user may cycle between them by pressing the “SET” button located on the back of the receiver, on the upper right-hand side of the cord storage area.
7. When the racking operation is complete, turn off all devices and place on the applicable charger. CBS ArcSafe® recommends leaving devices plugged into the applicable charger when not in use.

### ***F.1.2.2 Wireless Camera with Magnetic Mount***

This section will detail the setup and operation of the wireless video system for both the flexible base and fix mount magnetic cameras. For camera systems fix mounted to the RRS-1, please see the previous section.

1. Place the camera in the location where it will be utilized to remotely view the racking operation by attaching the magnetic mount located on the bottom of the camera base to a magnetic surface. Ensure that the magnet sits flush against the surface with no obstructions. If using the flexible base magnetic camera please skip to step 4.

#### **ATTENTION!**

Ensure that the location and position of the camera and remote power supply will not interfere with the remote racking procedure.

2. Next, attach the remote camera power supply to a magnetic surface near the camera.





**Figure F-4:** Wireless Camera Remote Power Supply

- Next, attach the 3 pin twist style connector from the camera to the remote power supply.

**ATTENTION!**

Ensure that all cords and cables are clear of moving parts. Interference may cause damage to cables and/or switchgear and may adversely affect the racking procedure.

- Power on the magnetic camera by flipping the red rocker switch on. A light within the switch will illuminate to signal the user that the unit is powered on. A battery indicator to the left of the switch shows the remaining amount of battery power. Please ensure that the power supply is fully charged or plugged into AC power prior to operating the wireless camera system.

**ATTENTION!**

Do not leave the charger plugged into the remote power supply when not plugged into AC power. The charger will slowly bleed the battery power to zero if left plugged in.

- With the camera switch in the "ON" position, the fix mounted camera is now powered on and transmitting a video signal wirelessly to the receiver located in the monitor and receiver case.
- Open the monitor and receiver case and power on the system by turning the green power button clockwise. A light within the switch will illuminate to signal the user that the unit is powered on. The initial charge was performed by CBS ArcSafe®; all subsequent charges are performed by plugging the LCD power cable into AC power. Please ensure that the internal batteries are charged or that the unit is plugged into AC power before operation.
- Next, power on the monitor using the power button located on the bottom right side of monitor.
- If multiple inputs are being utilized, such as a magnetic and fix mounted camera, the user may cycle between them by pressing the "SET" button located on the back of the receiver, on the upper right-hand side of the cord storage area.
- When the racking operation is complete, turn off all devices and place on the applicable charger. CBS ArcSafe® recommends to leave devices plugged into the charger when not in use

## Appendix G: Pneumatic Tires

This section will describe to the user the proper RRS-1 operation and required maintenance for a unit equipped with pneumatic tires.

### *G.1 Components*

The pneumatic tire option consists of a set of pneumatic tires mounted in the rear of the unit which serve as the main transportation wheels when moving the unit from one location to another. The pneumatic wheels are especially useful for environments consisting of uneven, rocky, or gravel surfaces. The cushioning effect of the air filled tire also reduces wear on the RRS-1 unit during transport. An RRS-1 equipped with pneumatic tires is shown in the following image.



**Figure G-1:** Pneumatic tires installed on an RRS-1

## **G.2 Maintenance**

Pneumatic tires require somewhat more scheduled maintenance than standard solid rubber tires due to the fact that they are pressurized with air. Before being shipped, CBS ArcSafe® fills each tire with a sealant which improves air retention and prevents flat tires. However, periodic checking of the air pressure is required to ensure that the tires do not become flat. Perform the following maintenance at the specified interval:

- Prior to transport – Check tire pressure using an accurate tire pressure gage. Tire pressure reading should be 30 psi  $\pm$ 10%. If it is not, adjust tire pressure by adding or removing air to get to the correct reading.
- Once per year – Check for dry rotted or weather rotted rubber areas on the tires. Signs of this include cracks along the outer surface of the tire. If found, replace tires immediately as these could rupture when pressurized. Contact CBS ArcSafe® for replacement tires.
- Once per year – Grease the wheel bearings to ensure long bearing life and prevent squeaking, binding, or premature failure.

# Appendix H: Stair Climber Rails

This section will describe the applicable components and the application of stair climber rails.

## H.1 Components

The stair climber rails assist users in transporting the RRS-1 unit up and down stairways by allowing the unit to slide along the stairs rather than have to maneuver up or down each stair individually. In addition, the stair climber rails also provide protection to the back side of the control cabinet and create a backstop on the back side of the machine. This upgrade consists of a pair of stair climber rails, with one being mounted to each side of the RRS-1 unit onto the upright hoops. An RRS-1 equipped with this option is shown in the following figure.



**Figure H-1:** Stair climber rails installed on RRS-1

## H.2 Application

### ATTENTION!

Use of the stair climber rails to ascend or descend stairs may require more than one person. Always follow in house or industry regulations regarding maximum lifting weights.

Follow the procedure below to transport the RRS-1 unit up or down stairs:

1. Ensure that the RRS-1 unit is powered down and that all tooling or accessories are removed from the machine.
2. Next, make sure that all attached coil cords and/or pendants are secured to the machine properly in such a way that they will not come loose during transport.
3. Ensure that the storage bag is zipped closed so that the contents do not accidentally fall out during transport.
4. Check to see that the control cabinet access door in the rear of the machine is closed securely so that it will not open during transport.
5. Wheel the unit to the stairs to be traversed and position the unit as follows based on the operation to be performed:
  - a. For ascending stairs, position the RRS-1 so that the backside of the unit where the stair climber rails are mounted is facing the stairs.
  - b. For descending stairs, position the RRS-1 so that the front side of the unit opposite of where the stair climber rails are mounted is facing the stairs.
6. Next, tilt the machine back and place unit so that the stair climber rails are resting against the stairs.
7. Lastly slowly guide the machine up or down the stairs.
8. Once complete, inspect the RRS-1 to ensure that no damage was suffered during the process.

# Appendix I: Magne-blast Supervisory Link

The CBS ArcSafe® Magne-blast Supervisory Link (MBSL) is designed to allow the RRS-1 to interface with the preexisting control circuit and cubicle mounted limit switches in General Electric (GE) Magne-blast AM-4.16 and AM-13.8 switchgear. In doing so, the RRS-1 is linked to the factory elevating motor control circuit. This link allows the RRS-1 to operate seamlessly with the Magne-blast gear, using the built in limit switches as operational stops just as the factory elevating motor does. The MBSL feature is compatible with all Magne-blast control voltages and most control schemes.

## I.1 Components

This section will highlight the main components that will be utilized when using the RRS-1 with the MBSL option. Some of these components may already be installed on the RRS-1; however, only the additional functionality of these components which will be utilized only during MBSL assisted remote racking will be described here. American Magne-blast cubicle and components shown below: Canadian version will vary slightly but still utilize similar components.

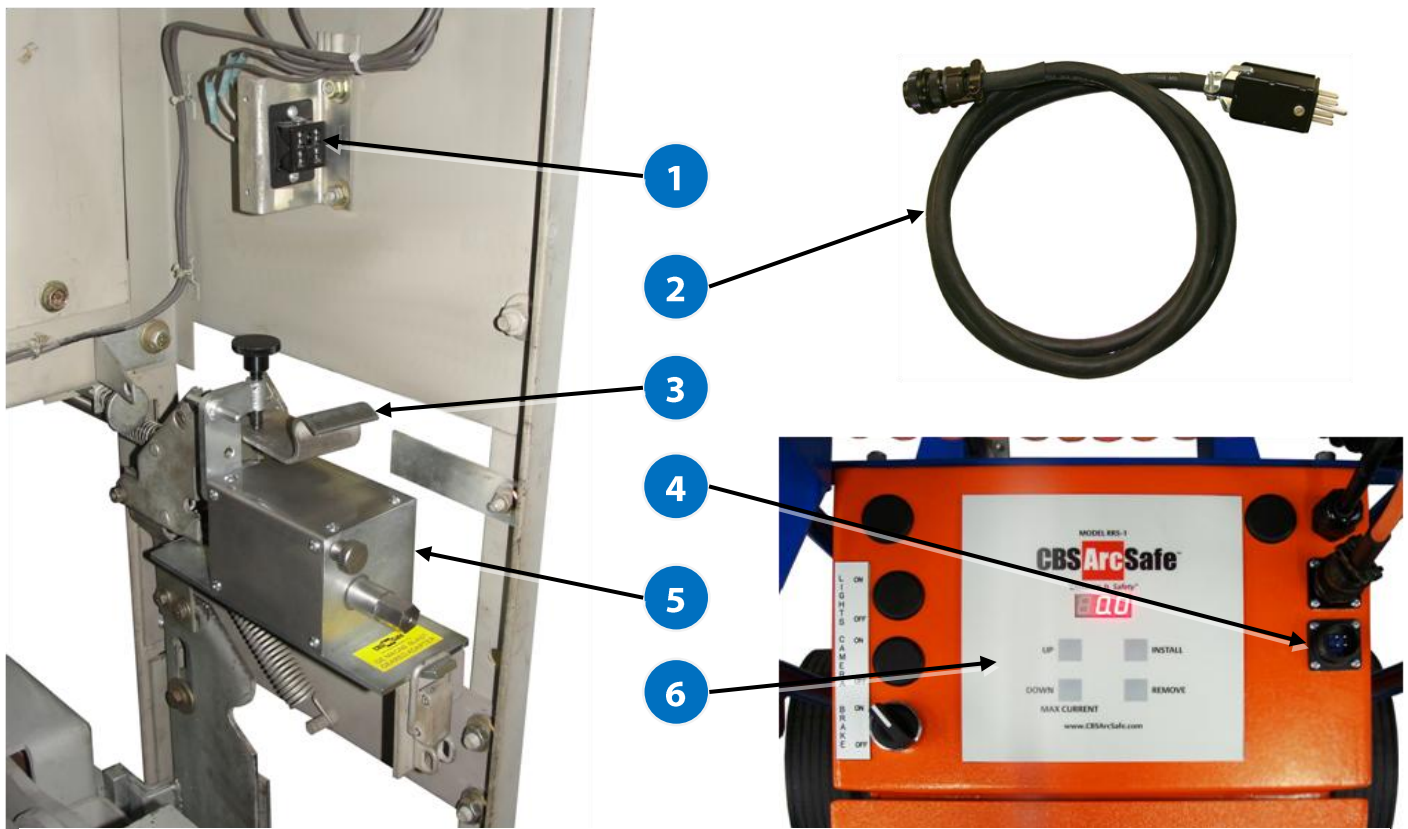

- 1. Factory Elevating Motor Power Receptacle
- 2. MBSL Cable
- 3. Engagement Lever
- 4. RRS-1 MBSL Cable Receptacle
- 5. Magne-blast Geared Adapter (MBGA)
- 6. Current Control Module (CCM)

Figure I-1: MBSL Components

**Factory Elevating Motor Power Receptacle ( Figure I-1.1 )** – The factory elevating motor power receptacle will be located in the area immediately above the factory racking motor pedestal. When installed, the factory elevating motor’s power cord will plug into this receptacle and draw power from it. When using the RRS-1, the MBSL feature must also interface with this receptacle via the MBSL cable in order to monitor the breaker’s location and stop the RRS-1 once the breaker has been fully racked to the applicable position.

**MBSL Cable ( Figure I-1.2 )** – The MBSL cable is used to interface between the RRS-1 and Magne-blast cubicle. The MBSL cable attaches to the RRS-1 using the MBSL cable receptacle located on the top side of the control cabinet via the four pin threaded style connector. The MBSL cable attaches to the Magne-blast cubicle in the same location as the factory elevating motor’s power cable via a 5 pin plug.

**Engagement Lever ( Figure I-1.3 )** – The engagement lever is located within the Magne-blast cubicle and is part of the Magne-blast’s racking mechanism. The engagement lever is required for operation and must be fully actuated prior to operation to both couple the drive mechanism to the racking mechanism and to close a switch which allows the cubicle mounted limit switches to function properly. The actuation of the upper and lower cubicle mounted limit switches limits the travel of the breaker in the install and removes directions, respectively.

**MBSL Cable Receptacle ( Figure I-1.4 )** – The MBSL cable receptacle is located on the top side of the control cabinet on all MBSL equipped units. This four pin threaded receptacle is used to interface between the RRS-1 and the Magne-blast control circuit for MBSL operation. The connection is made by connecting the applicable end of the MBSL cable to both the Magne-blast cubicle and the RRS-1.

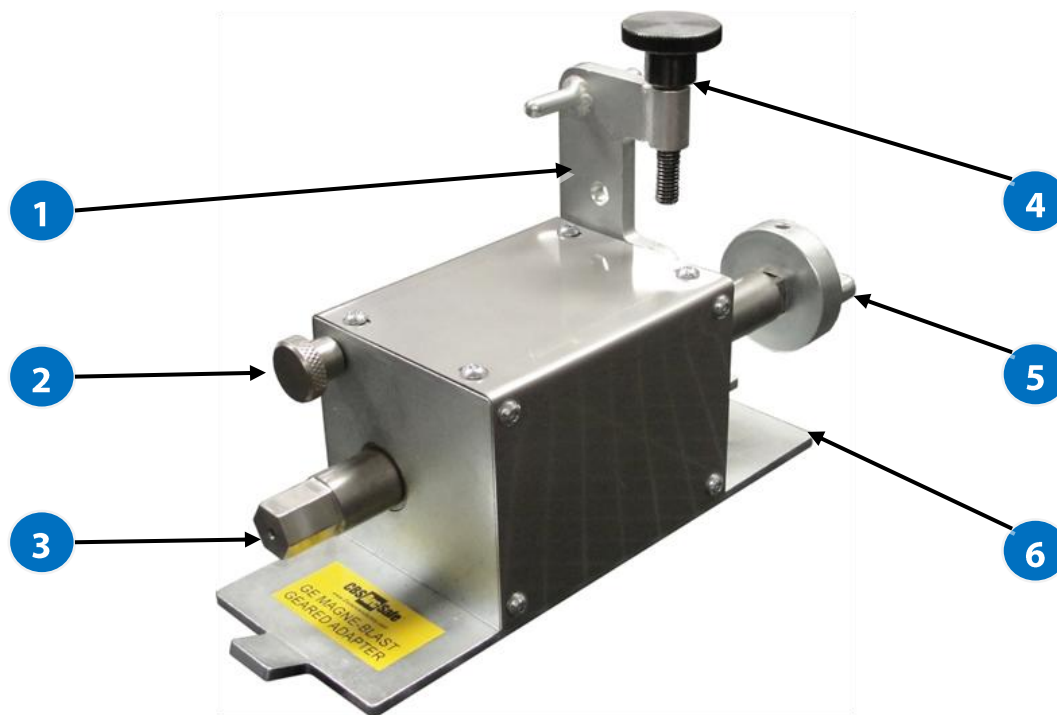

- |                                     |                                      |
|-------------------------------------|--------------------------------------|
| 1. Engagement Lock Lever            | 4. Engagement Lock Lever Thumb Screw |
| 2. Engagement Lock Lever Spring Pin | 5. Output Shaft                      |
| 3. Input Shaft                      | 6. Base Plate                        |

**Figure I-2: Magne-blast Geared Adapter**

**Magne-blast Geared Adapter ( Figure I-1.5, Figure I-2 )** – The Magne-blast Geared Adapter (MBGA) is used to couple the RRS-1 drive assembly to the Magne-blast racking mechanism. The MBGA mounts in place of the factory elevating motor and is secured using the same latching method as the motor (Contact CBS ArcSafe® for solutions regarding bolt in motor applications). In addition, the MBGA has the capability to hold the engagement lever in place throughout the duration of the racking operation, allowing full usage of the built-in circuitry without the need for an operator to manually actuate the lever.

**Current Control Monitor ( Figure I-1.6 )** – The Current Control Monitor (CCM) provides instantaneous running current of the motor during an MBSL assisted racking operation. Additionally, the CCM may provide breaker location feedback as well as have the ability to adjust certain operational parameters internally. These additional MBSL features may or may not be available depending on the firmware version installed in the CCM; please refer to Section 3.1 for information detailing how to identify which version of CCM firmware is present on the RRS-1. In the case of faulty or non-operational control power, the current control monitor will also allow the operator to rack the breaker by monitoring motor current (See Section I.4.2 for more information regarding racking the GE Magne-blast in CCM mode).

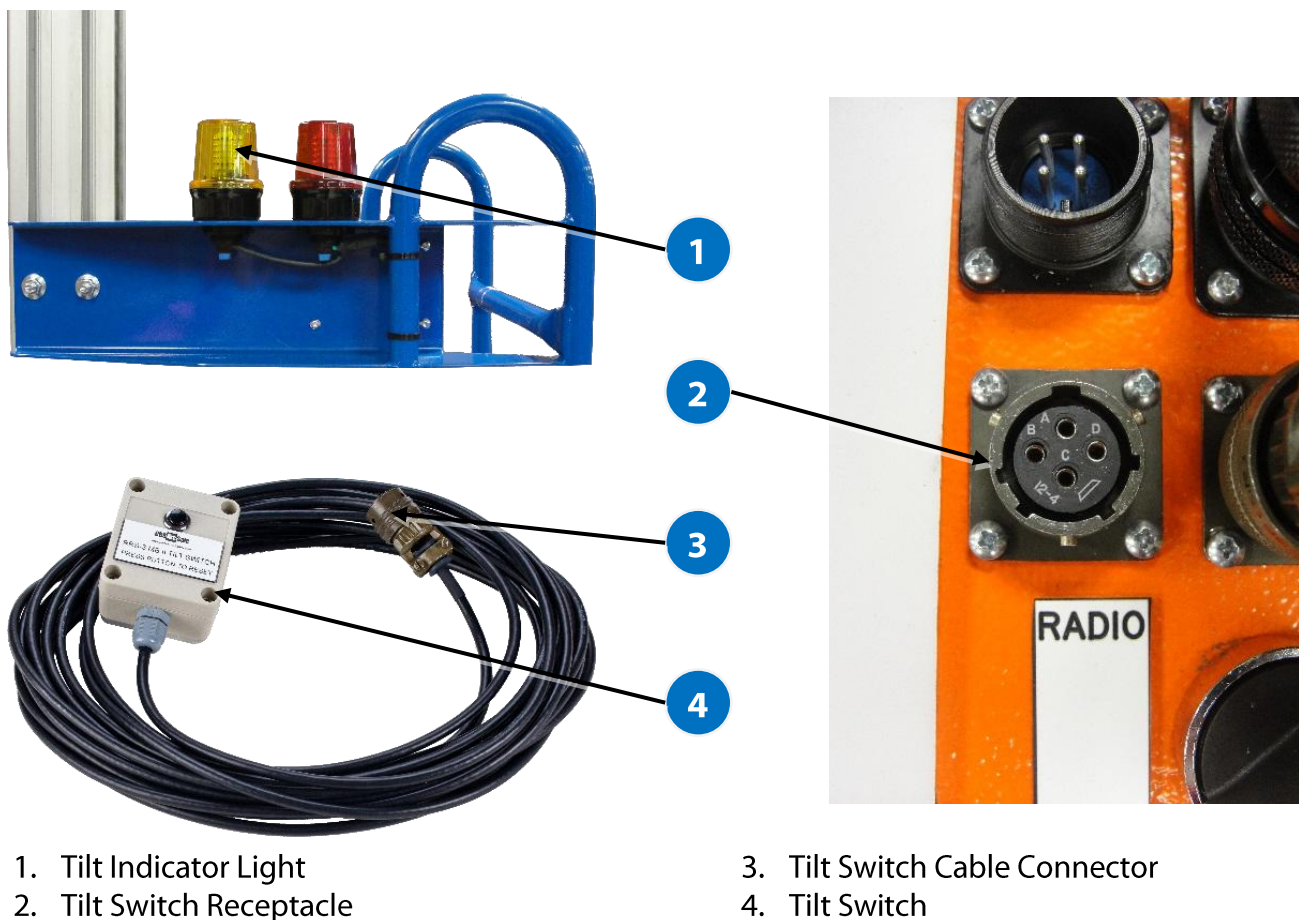

- 1. Tilt Indicator Light
- 2. Tilt Switch Receptacle
- 3. Tilt Switch Cable Connector
- 4. Tilt Switch

**Figure I-3:** Tilt Switch Components

**Tilt Switch (Optional) (Figure I-3.4)** – The optional tilt switch uses a magnetic tilt sensor to monitor the tilt of the Magne-blast breaker during racking. A potentially dangerous situation may occur during racking if the racking mechanism chain skips a link or breaks during the operation. The tilt switch package constantly monitors the tilt of the breaker (Both forward to back and side to side independently) during the racking



operation and will alert the user if an unsafe tilt condition has been recognized as the result of a racking mechanism malfunction. The tilt switch mounts magnetically to the top of the breaker, and is connected to the tilt switch receptacle on the top side of the RRS-1 control cabinet. This receptacle accepts the 4 pin twist style connector of the 30' cord to the tilt switch. The tilt indicator light alerts the user to a potentially dangerous tilt situation when the tilt switch attached to the breaker has been triggered.

## I.2 Preparation

This section will detail the necessary steps that must be taken prior to setting up or operating the RRS-1 using MBSL mode. The information provided in this section is critical for ensuring that the RRS-1 will work properly when set up for MBSL operation. This section will be divided up into standard (I.2.1) and Canadian (I.2.2).

### I.2.1 Cubicle Identification (United States Only)

This section will detail how to identify which style of control power circuit is present on the US GE style of Magne-blast gear to be remotely racked. Prior to beginning any racking procedure using the RRS-1 in MBSL mode, the user must identify which style of control power will be utilized during the racking operation. GE manufactured several different styles of Magne-blast cubicles, with each utilizing one of two known control power schemes. The RRS-1 is equipped to operate in MBSL mode in conjunction with only the newer style control power scheme.

#### **DANGER!**

The RRS-1 will only operate in MBSL mode correctly when in conjunction with a Magne-blast cubicle with the correct control power scheme. The vast majority of Magne-blast gear in use today is equipped with the newest control power style. The RRS-1 is designed to work in MBSL mode with this newest style of control power. If the remote racking operation of a Magne-blast circuit breaker is taking place within a cubicle equipped with the older style of control power scheme, please contact CBS ArcSafe® for solutions.

To identify the style of control circuit which is present on the Magne-blast to be remotely racked please see the following figure which helps to identify each type. The graphic shown below illustrates the different styles of switches used to operate the factory elevating motor found in standard GE Magne-blast gear.



**Figure I-4:** Factory elevating motor switches

**Type 1 Control Power** – “Type 1” control power can be easily recognized when inspecting the factory elevating motor. “Type 1” cubicles are identified as operating with a universal AC/DC motor with the raise/lower toggle switch located on the upper backside of the motor. This style of cubicle DOES NOT have an elevating motor control switch located inside the cell. Cubicles with this control power configuration are the newest generation of Magne-blast manufactured and are the most common style. For more detailed information on recognizing “Type 1” control power, please contact CBS ArcSafe®.

**Type 2 Control Power** – “Type 2” control power can be easily recognized when inspecting the factory elevating motor. “Type 2” cubicles are identified as operating with a DC shunt wound motor with no toggle switch located on the motor. This style of cubicle DOES HAVE an elevating motor control switch located inside of the cell. Cabinets with this control power configuration represent a small percentage of the existing Magne-blast switchgear in use today and are among the older generation of the switchgear. For more detailed information on recognizing “Type 2” control power, please contact CBS ArcSafe®.

### **ATTENTION!**

The RRS-1 will not function properly when operating in MBSL mode for “Type 2” control power as provided. Please contact CBS ArcSafe® for solutions regarding “Type 2” control power applications.

## **I.2.2 Cubicle Identification (Canadian Only)**

This section will detail how to identify which style of control power circuit is present on the Canadian GE style of Magne-blast gear to be remotely racked. Prior to beginning any racking procedure using the RRS-1 in MBSL mode, the user must identify which style of control power will be utilized during the racking operation. GE manufactured several different styles of Magne-blast cubicles, with each utilizing one of two known control power schemes. The RRS-1 is equipped to operate in MBSL mode in conjunction with only the newer style control power scheme.

### **DANGER!**

The RRS-1 will only operate in MBSL mode correctly when in conjunction with a Magne-blast cubicle with the correct control power scheme. The vast majority of Magne-blast gear in use today is equipped with the newest control power style. The RRS-1 is designed to work in MBSL mode with this newest style of control power. If the remote racking operation of a Magne-blast circuit breaker is taking place within a cubicle equipped with the older style of control power scheme, please contact CBS ArcSafe® for solutions.

To identify the style of control circuit which is present on the Magne-blast to be remotely racked please see the following figure which helps to identify each type. The graphic shown below illustrates the different styles of switches used to operate the factory elevating motor found in standard GE Magne-blast gear.



**Type 1**



**Type 2**

**Figure I-5:** Canadian factory elevating motor switches

**Type 1 Control Power** – “Type 1” control power can be easily recognized when inspecting the factory elevating motor. “Type 1” cubicles are identified as operating with a universal AC/DC motor with the raise/lower toggle switch located on the upper backside of the motor. This style of cubicle DOES NOT have an elevating motor control switch located inside the cell. Cubicles with this control power configuration are the newest generation of Magne-blast manufactured and are the most common style. For more detailed information on recognizing “Type 1” control power, please contact CBS ArcSafe®.

**Type 2 Control Power** – “Type 2” control power can be easily recognized when inspecting the factory elevating motor. “Type 2” cubicles are identified as operating with a DC shunt wound motor with no toggle switch located on the motor. This style of cubicle DOES HAVE an elevating motor control switch located inside of the cell. Cabinets with this control power configuration represent a small percentage of the existing Magne-blast switchgear in use today and are among the older generation of the switchgear. For more detailed information on recognizing “Type 2” control power, please contact CBS ArcSafe®.

### ATTENTION!

The RRS-1 will not function properly when operating in MBSL mode for “Type 2” control power as provided. Please contact CBS ArcSafe® for solutions regarding “Type 2” control power applications.

## I.2.3 MBSL Control Power Voltage Requirements

In addition to the two different control power schemes found in GE Magne-blast switchgear, users must also be aware of the control power voltage present within the cubicle. This control power, which is utilized within to power the limit switches and factory elevating motor, may be found in one of five different voltage configurations. The five standard voltage configurations are 48 VDC, 120 VAC, 125 VDC, 230 VAC, and 250

VDC. For RRS-1 units equipped with CCM firmware versions prior to “v3.0”, users must know the control voltage due to the fact that MBSL mode operation in these units is voltage specific. However, RRS-1 units equipped with “v3.0” firmware and newer are universal and will operate with any of the 5 control voltage configurations. See Section 3.1 Current Control Monitor for details on identifying the CCM firmware version.

### **I.2.3.1 Measuring Control Voltage**

For users utilizing RRS-1 units equipped with CCM firmware prior to “v3.0” which have voltage specific functionality regarding MBSL mode operation, the control voltage must be known. To measure the control voltage, please follow these steps:

1. First, inspect the images shown in Figure I-6 (Standard Cable) and Figure I-7 (Canadian Cable) and study the pin layout.

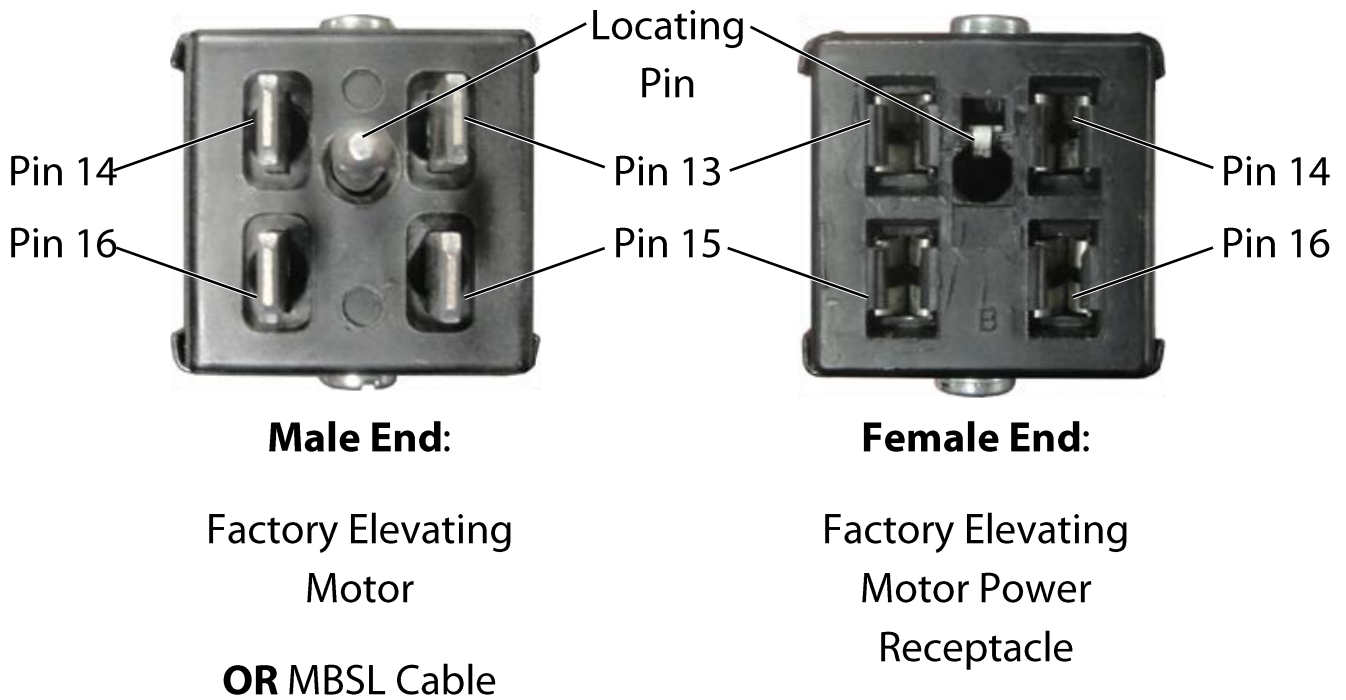

**Figure I-6:** Standard MBSL Cable Pin Layout

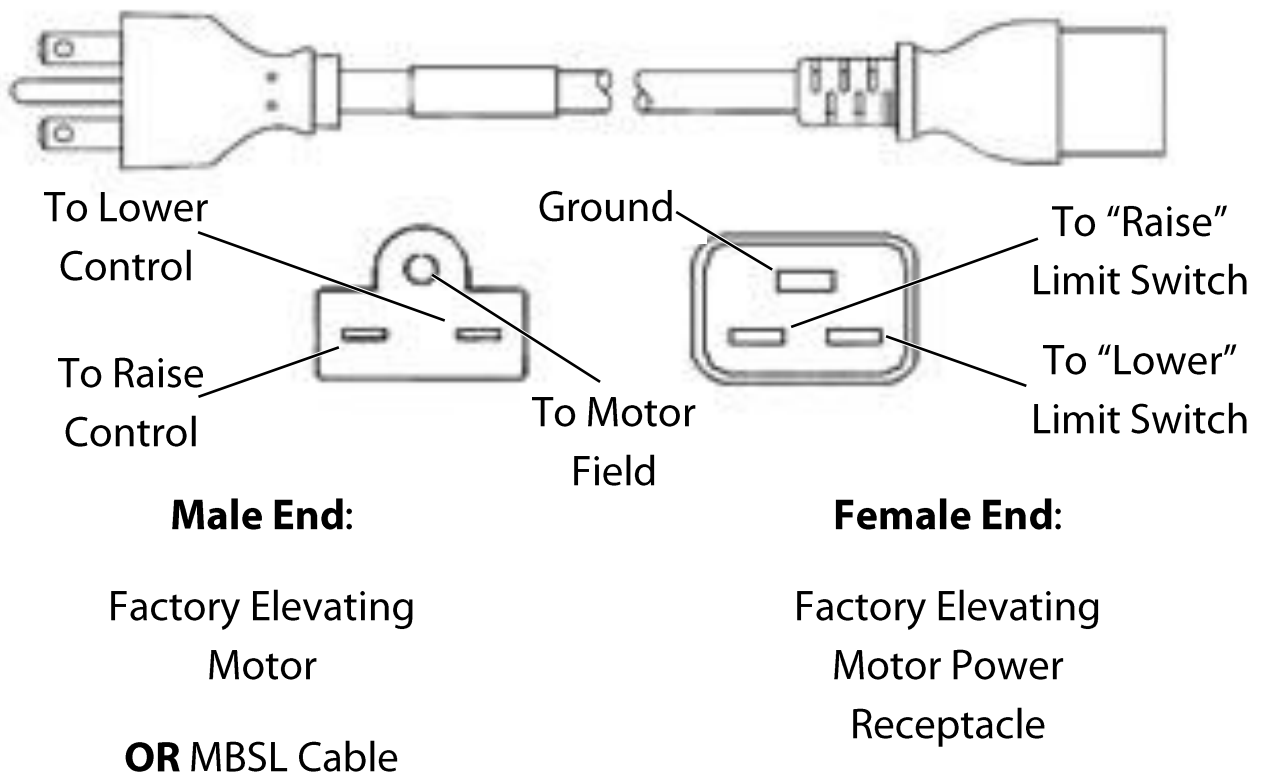

**Figure I-7:** Canadian MBSL Cable Pin Layout

2. Next, determine what position the Magne-blast circuit breaker is in: either fully installed, fully removed, or neither.
3. For standard MBSL configurations, see below. For Canadian configurations, contact CBS ArcSafe®. With a multimeter, test voltage on the female end (Factory elevating motor power receptacle) located within the Magne-blast cubicle according to the breaker location as follows:
  - a. If fully installed, test voltage across pins 15 and 13.
  - b. If fully removed, test voltage across pins 15 and 14.
  - c. If neither, test voltage across either pins 15 and 13 or pins 15 and 14.
4. The voltage reading should correspond closely with one of the 5 previously mentioned control voltage configurations. If it does not, contact CBS ArcSafe® for more information.

### ***1.2.3.2 MBSL Control Power Voltage Relay Setup for Firmware Versions Prior To "v3.0"***

RRS-1 units equipped with CCM firmware prior to "v3.0" have voltage specific functionality regarding MBSL mode operation. Because of this, two internal "Ice Cube" style relays must match the specific control voltage present on the switchgear to be racked. This section will explain how to determine which relays are present, and how to change them if necessary. Performing this procedure require

opening the control cabinet access door. Ensure that power is off and that the unit is not plugged in prior to performing any maintenance within the control cabinet.

### ATTENTION!

Canadian style Magne-blast is not compatible with firmware versions prior to “v3.0”.

### DANGER!

NOTE: This procedure is NOT applicable on RRS-1 units equipped with CCM’s running firmware version “v3.0” or newer which utilize a universal voltage sensor and do not require voltage specific hardware.

1. First, ensure that the main disconnect supplying power to the RRS-1 is in the “OFF” position and that the unit is not plugged into AC power. Also ensure that the MBSL cable is not connected between the RRS-1 and the Magne-blast cubicle.
2. Next, access the interior of the control cabinet by rotating the latch on the rear access door of the cabinet.
3. With the access door open users should now be able to find the relays which control MBSL assisted racking operations.
4. The two “Ice-Cube” style relays are located in the upper right hand corner of the back-plate in the control cabinet. The relays should look similar to the relays in Figure I-8 on page 110.



**Figure I-8:** “Ice-Cube” Style Relays

5. These relays may be removed simply by pulling them from their base. There may be a small spring wire restraint holding them in place. If so, first remove the wire to remove the relay.

6. On the relay there should be a voltage which corresponds to one of the 5 applicable control power voltages previously mentioned. The value shown on the relay itself should match a placard on the RRS-1 located on the top side of the control cabinet near the MBSL Cable Receptacle.
7. The rated voltage of the relays should match the nominal voltage of the control power system of the Magne-blast switchgear where the RRS-1 will be used. If the voltage does not match, contact CBS ArcSafe® for replacement or spare relays.

## **I.3 Installation and Setup**

This section will describe the installation procedure for all components required for MBSL assisted remote racking as well as the setup of certain operational parameters.

### **I.3.1 Requirements for MBSL Assisted Remote Racking**

Before performing any MBSL assisted remote racking procedure, please ensure that the following prerequisites have been met:

- The circuit breaker racking mechanism is in proper working order and functions correctly during install and remove operations.
- The circuit breaker has been properly maintained with all parts in proper working order.
- The cubicle mounted mercury or mechanical switches are properly adjusted and fully functional.
- The circuit breaker is in the applicable position based on the operation to be performed and OPEN according to manufacturer specifications.
- Control power is available to the control power receptacle and is in working order.
- The correct style of control power is present on the cubicle where remote racking will be taking place, as discussed in Section I.2.

#### **DANGER!**

For your safety please ensure that all personnel follow the personal protective equipment rules and regulations along with following all of the manufacturer guidelines at ALL times.

### **I.3.2 Installation**

Use the following installation procedure to install the drive assembly onto the switchgear and connect all cords to the RRS-1 and switchgear. Please ensure that all cords are clear of moving parts prior to operation; interference can damage cords and/or equipment.

This procedure assumes that the circuit breaker is installed in the cubicle and is in either the fully raised (Installed) or lowered (Removed) position. To install all necessary components and prepare the RRS-1 for MBSL operation, perform the following steps:



## **DANGER!**

Installation of the MBSL components for use with the RRS-1 requires personnel to open the door of a potentially energized cubicle. Ensure proper personal protective equipment (PPE) is worn and electrical safety practices are followed.

Only electrical technicians familiar with the risks associated with HIGH VOLTAGE equipment should operate the CBS ArcSafe® RRS-1.

1. First, ensure that the breaker to be operated is "OPEN" by checking that both the "OPEN" indicating light (if applicable) is illuminated and that the mechanical indicator on the breaker displays "OPEN" as well. If it is not, make sure to open the breaker before continuing.
2. Next, verify that the breaker is in either the fully connected (Upper position) or fully disconnected (Lower position) position and contacting the applicable limit switches at this point.
3. If a factory elevating motor is installed, please remove by following these steps:
  - a. Disconnect the elevating motor control power plug from the cubicle elevating motor receptacle.
  - b. Unlatch the draw latch below the elevating motor.
  - c. Remove the stock elevating motor.
4. Place the Magne-blast Geared Adapter (MBGA) onto the elevating motor platform. Install the MBGA to the correct location using the two locating dowels mounted on the bottom of the base plate to maintain alignment.
5. Secure the MBGA into place by latching the draw latch on the backside of the assembly base plate.

## **NOTE:**

If the latch is either too loose or too tight, the location of the latch itself may be adjusted to work with the MBGA. Loosen the two screws on the backside of the latch mount to provide the necessary adjustment. Once correctly positioned, retighten both screws to secure the latch in its newly adjusted position.

6. With the MBGA securely latched into place, pull the engagement lever in the cubicle toward the geared adapter and engage the drive head of the MBGA with the cubicle mounted racking mechanism. Ensure that the drive head mates properly with the cubicle mounted racking mechanism; hand rotation of the geared adapter may be necessary for proper alignment.

## **ATTENTION!**

Please ensure that the drive head of the MBGA mates correctly with the cubicle mounted racking mechanism. Improper alignment may cause difficulties during operation.

## ATTENTION!

If the axis of rotation of the MBGA's drive head does not align with the axis of rotation of the cubicle mounted racking mechanism when the engagement lever is pulled, the elevating motor platform may need to be repositioned. Contact CBS ArcSafe® for more information on adjusting the elevating motor platform.

7. With the engagement lever pulled toward the MBGA and drive head aligned, use the engagement lever latch located on the front of the MBGA (See Figure I-2.2) to hold down the lever by following these steps
  - a. Rotate the engagement lever latch over the top of the engagement lever, all the while keeping the engagement lever pulled toward the MBGA.
  - b. With the engagement lever latch properly positioned over the engagement lever, secure in place using the spring loaded pin on the back of the MBGA.
  - c. To secure the engagement lever in place, tighten the thumb screw on the latch until the engagement lever sits firmly in place.

## ATTENTION!

When lowered, the engagement lever operates a linkage below which engages a limit switch. The engagement lever may need to be adjusted in order to engage the mercury limit switch properly. If during operation the MBSL is not functioning properly this switch may not be fully engaged and therefore preventing the supervisory link from working properly. In this case, it may be necessary to adjust the linkage or the mercury switch itself. Make any necessary adjustments to the system and check to ensure that when the engagement lever is lowered the mercury switch is now being fully engaged.

## DANGER!

Before performing any electrical maintenance operation please ensure that the proper plant operating procedures are always followed and all PPE requirements are met and/or followed.

8. With the MBGA properly installed the RRS-1 may now be installed as well. First, ensure that the torque limiter has been set to an appropriate value. Setting or measuring the value of the torque limiter may be performed by following the steps outlined in Section 3.3 Torque Limiter in this manual. For more information on breaker specific torque settings contact CBS ArcSafe®.

## DANGER!

Inaccurate setting of the torque limiter can result in operational issues. Setting the torque limiter too low will result in excessive slip during the remote racking operation; while setting the torque limiter too high may exert excessive torque onto the breaker racking mechanism, possibly causing equipment damage. Always be sure to set the torque limiter to the proper setting before beginning a remote racking operation.

9. Next, position the RRS-1 unit in front of the cubicle and begin to align the unit. Align the unit so that the axis of rotation of the spring loaded drive head corresponds to the axis of rotation of the MBGA's input shaft.

10. Place the CBS ArcSafe® racking tool onto the geared adapter. Wheel the machine to the breaker and install the tool onto the spring loaded drive head.

### ATTENTION!

If the tool does not align with the drive head of the RRS-1, power the machine on and turn the brake to the "OFF" position. This will allow the user to rotate the drive head to align with the installed tooling.

11. Once the tooling has been attached to the RRS-1, engage the floor locks on the backside of the RRS-1 to keep it in place while performing the remote racking operation.
12. Next, install the MBSL cable between the four pin threaded receptacle on the top of the control cabinet and the factory elevating motor receptacle found in the cubicle. If users are operating "Type 1" Magne-blast gear with the elevating motor control switch mounted on the motor, please install the cable between the two receptacles and proceed to step 14. However, if users are operating "Type 2" Magne-blast gear with the elevating motor control switch installed within the cubicle, please do not install the cable and proceed to see step 13.
13. If operating "Type 2" style Magne-blast gear (Canadian or American) which has the elevating motor control switch installed within the cubicle, users must perform the following steps for MBSL assisted racking:
  - a. To rack a "Type 2" Magne-blast using the RRS-1, users will have to install an inline conversion box between the RRS-1 and the Magne-blast cubicle. To do so, first install the provided MBSL cable into the four pin threaded receptacle on the top side of the control cabinet. Plug the other end of the MBSL cable into the applicable receptacle on provided conversion box. Finally, plug the other end of the cable from the conversion box into the receptacle within the cubicle. The conversion box is equipped with a magnetic base to allow users to place it conveniently anywhere within the switchgear. If users do not have this inline conversion box please contact CBS ArcSafe® for more information.

### NOTE:

MBSL assisted racking WILL NOT work properly on a "Type 2" Magne-blast cubicle without the inline conversion box.

### ATTENTION!

Please ensure that all cables are clear of moving parts. Failure to do so may result in damage to cables and/or equipment.

- b. Next, place the switch on the conversion box in the applicable position for the operation taking place. For example, if the user wishes to rack the Magne-blast to the lowered or "Removed" position, place the switch in the corresponding "Remove" position.

## ATTENTION!

If the operator does not install the MBSL cable, the RRS-1 will function as a standard RRS-1. For instructions on racking a Magne-blast breaker WITHOUT using MBSL please see section I.4.2.

14. If applicable, mount the tilt sensor onto a horizontal level surface of the breaker where it will not interfere with the racking operation and connect the tilt sensor cord to the tilt sensor receptacle on the topside of the control cabinet. If applicable, reset the tilt sensor to correspond to its current location by pressing the "RESET" button on the top side of the tilt sensor (RRS-1 power must be on to reset the device).

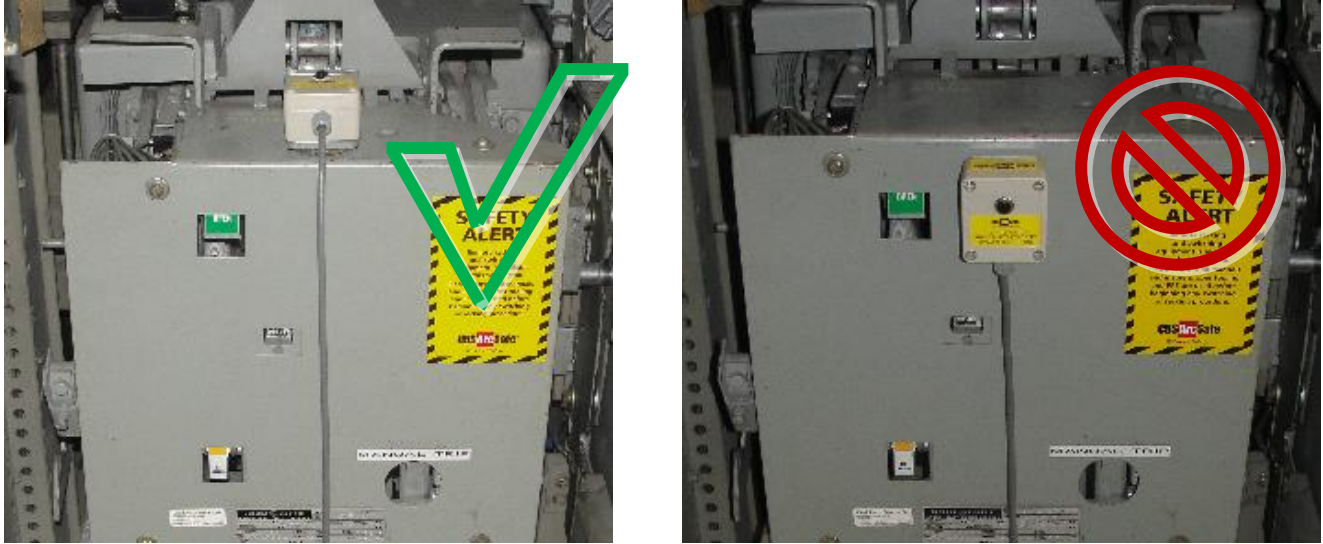

**Figure I-9:** Tilt Switch Installation

## ATTENTION!

Please ensure that all cables are clear of moving parts. Failure to do so could damage cables and/or equipment.

15. Power on the RRS-1 and ensure that the batteries are fully charged or that the unit is running on AC power.

## ATTENTION!

Due to its large size and vertical racking direction, racking a Magne-blast breaker creates a higher current draw on the RRS-1 than most applications. CBS ArcSafe® recommends that users plug in the RRS-1 and operate using wall power during remote racking operations.

16. For firmware versions prior to "v3.0" please continue on to step 18. For all versions "v3.0" and higher please continue with step 17.
17. Once powered on, the RRS-1 CCM display should read as follows with position indication dot corresponding to the breaker's position. The position indication dot can be found between the first two characters as shown in the following images:

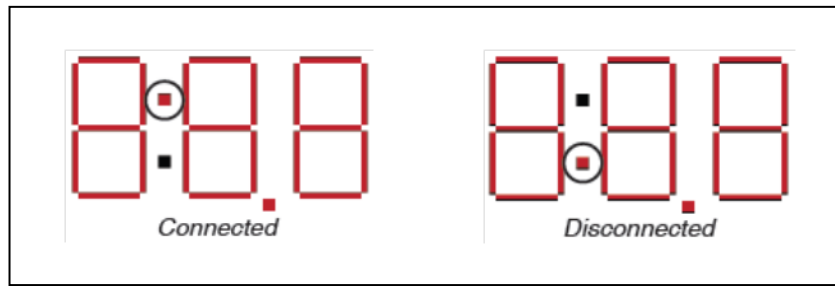

**Figure I-10:** CCM display for disconnected and connected position

- a. If the proper position indication dot is displayed as shown, all circuitry within the Magne-blast cubicle is working properly, please proceed to step 18.
  - a. If there is no visible position indication dot, discontinue use immediately and contact CBS ArcSafe® for troubleshooting procedures. Check for any blown fuses within the cubicle and replace if necessary.
  - b. If the position indication dot is in the opposite position as the breaker, discontinue use immediately and refer to the troubleshooting section.
18. Next, setup the CCM in the same manner as manual mode by setting the install and remove set points to 0.0 as directed in Section 3.1.4.

### **DANGER!**

If the operator does not set the current control monitor set points to zero, the Magne-blast supervisory link option will not function correctly and the RRS-1 will revert to automatic operation and monitor current only.

19. The RRS-1 is now setup for MBSL assisted remote racking.

### **I.3.3 Coast-Down Timer Setup**

On properly equipped RRS-1 units, the MBSL overrides control of the RRS-1 when the unit is setup for operation in manual mode and the MBSL cable is attached. The MBSL option incorporates a “coast-down” function which allows the RRS-1 to mimic operation of the factory elevating motor. When using the factory elevating motor, the high RPM and inertia of the motor’s rotating assembly cause the motor to rotate for a time period beyond the instant that the limit switch is triggered. Due to the fact that the RRS-1 drive motor is equipped with an automatic brake and rotates at approximately 25% of the speed of the factory elevating motor, the unit must operate for an extended period of time after the limit switch has been triggered in order to fully rack the breaker to the applicable position. The MBSL coast down feature extends the racking operation of the RRS-1 an adjustable amount of time beyond the instant that the limit switch is triggered. Operators can adjust this amount of time separately for both the install and remove operations to ensure that the Magne-blast breaker reaches the fully racked position during both operations.

The following section describes how to set the coast-down timers for RRS-1 units equipped with two different versions of firmware present within the CCM

### ***1.3.3.1 Coast-Down Timer Setup for Firmware Versions Prior to “v3.0”***

For RRS-1 units utilizing firmware versions prior to “v3.0”, the coast-down timer setup will consist of manually adjusting a small timer relay within the control cabinet. Making adjustments to this setting will require opening the control cabinet door. Ensure that power is off and that the unit is not plugged in prior to performing any maintenance within the control cabinet. Utilize the following procedure to set the coast-down time.

#### **DANGER!**

Circuit breaker ratings and physical condition can affect the required time delay settings. The coast-down setup procedure assumes that the Magne-blast circuit breaker and cubicle are properly adjusted in accordance with GE factory specifications, such as those listed in GE publication No. GE(H)-1802 “Metal-Clad Switchgear – Instructions & Renewal Parts”.

1. With the circuit breaker in the raised or fully connected position, make note of one or more of following with respect to the circuit breaker and cubicle.
  - Measure the secondary disconnect gap; the distance between the secondary disconnect receptacle and plug.
  - Measure the positive interlock gap; the distance between the “V” shape in the positive interlock plate and the breaker pin.
  - Measure the hard stop gap; the distance between the circuit breaker lifting bracket and the stop bolt.
2. Next, install the RRS-1 and ensure that all components required for MBSL assisted operation have been properly installed as described in Section 1.3.2 and that all requirements found in this section and Section 1.2 have been met.
3. Verify that the circuit breaker is “OPEN” according to manufacturer specifications.
4. Power on the RRS-1 and ensure that the batteries are fully charged or that the unit is running on AC power.
5. Next, remove the circuit breaker following the applicable operational procedure found in Section 1.4.
6. Once the breaker has been successfully removed it can then be reinstalled to check the INSTALL coast down timer setting. Install the circuit breaker following the applicable procedure found in section 1.4. Once fully installed, check all measurements that were previously recorded.
7. If adjustments are required, remove the RRS-1 from the switchgear following the procedures in section 1.4, power down the unit, and ensure that the unit is not plugged into AC power.

- a. First open the door on the backside of the control cabinet. Locate the INSTALL and REMOVE coast down timers pictured in Figure I-11. The INSTALL coast-down timer will be located on the left, the REMOVE coast-down timer will be on the right.
  - b. Next, adjust the INSTALL coast-down timer either clockwise (More time) or counterclockwise (Less time) based on the results of the test run(s).
8. Repeat steps 2-7 as necessary until the measurements taken previously match measurements taken after MBSL operation.
  9. Repeat steps 1-7 with the circuit breaker in the fully lowered position, with the right hand timer relay, or remove coast-down timer.

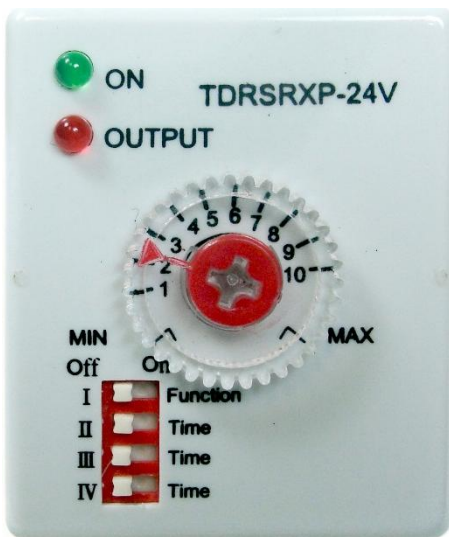

Time Range: 0.0 – 1.0 second

*Rotate the dial clockwise to raise the time delay.  
Rotate the dial counter-clockwise to lower.*

*DIP Switches I-IV should be set just as in this image:*

*I: Off*

*II: Off*

*III: Off*

*IV: Off*

**Figure I-11:** Coast down timer setup

### ***1.3.3.2 Coast-Down Timer Setup for Firmware Version “v3.0” and Newer***

For RRS-1 units with CCM firmware version 3.0 and newer, Coast-down timers are configured in the CCM. See Section 3.1.6.3 of this manual for more information.

## ***1.4 Operation***

### **DANGER!**

Operating CBS ArcSafe® equipment prior to training may void all warranties, written or implied.

This section will describe the necessary steps to install and remove the Magne-blast circuit breaker using the RRS-1 in MBSL (Magne-blast Supervisory Link) mode. Using this mode, the operator can install or remove the Magne-blast circuit breaker remotely and automatically using the breaker’s built in limit switches and

preexisting circuitry. In addition, this section will detail the use of the RRS-1 rack GE Magne-blast circuit breakers in the case of a faulty cubicle wiring setup.

This section will describe the operation of MBSL assisted RRS-1 remote racking. Please note that Section I.4.1 describes operation with the MBSL assist, while section I.4.2 describes operation without MBSL assist. When operating the RRS-1 to rack a GE Magne-blast, please refer to the proper section based on the unit being operated.

### I.4.1 MBSL Mode Operation

This section covers operation of the RRS-1 with the Magne-blast Geared Adapter in MBSL Mode.

#### I.4.1.1 MBSL Mode with Firmware Versions “v3.0” and Higher Operation

1. Ensure that all components required for MBSL assisted operation have been properly installed as described in the previous section. Also ensure that all requirements listed in sections I.2 and I.3 have been met.
2. Verify that the circuit breaker is “OPEN” according to manufacturer specifications.
3. If not already done, power on the RRS-1 and ensure that the batteries are fully charged or that the unit is running on AC power.
4. If the RRS-1 has been setup properly, the CCM display on the RRS-1 should read as follows with the corresponding dot between the first two characters lit when the unit is powered on.

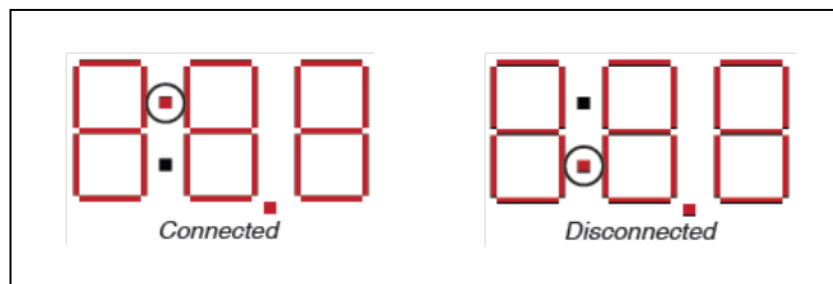

**Figure I-12:** CCM Display

5. If the dot is displayed as shown and in the proper position which corresponds to actual position of the circuit breaker in the cubicle, all components are working properly, continue to step 8.

#### ATTENTION!

An illuminated UPPER dot means that the breaker is in the Installed or UPPER position; an illuminated LOWER dot means that the breaker is in the Removed or LOWER position

6. If there is no visible dot, please try the following: If it is, discontinue use immediately and contact CBS ArcSafe® for troubleshooting information.



- a. Check to ensure that the breaker is in the fully installed or fully removed position and contact the corresponding limit switch at that position. If it is, continue to the next check. If it is not, correct the issue and return to the previous step and try again.
  - b. Next, check to ensure that the firmware present on the RRS-1 is version “v3.0” or higher. If it is not, please continue to Section I.4.1.2.
7. If the dot is illuminated, but in the incorrect position and does not correspond to the actual breaker position, discontinue use immediately and contact CBS ArcSafe® for troubleshooting information.

### **DANGER!**

If at this point in the procedure the lower dot is NOT displayed, or the upper dot is displayed although the circuit breaker is in the disconnected position, discontinue use right away and contact CBS ArcSafe®. Continued use beyond this point may damage equipment as the RRS-1 will not operate as intended.

8. Exit the arc flash boundary with the applicable pendant control (Either wired or wireless) to be used during remote operation and ensure that no personnel are present within the boundary prior to beginning the remote operation.

### **DANGER!**

Exiting the arc-flash protection boundary may prevent the operator from observing the circuit breaker during repositioning and the problems that can occur during racking. Contact CBS ArcSafe® for remote monitoring solutions.

9. Using the appropriate control method (wired or wireless) press and release the applicable “INSTALL” or “REMOVE” pushbutton to begin the racking procedure. The RRS-1 will begin the racking procedure and continue until it automatically shuts off when the circuit breaker has been fully repositioned and the internal switches in the cubicle have been triggered.

### **DANGER!**

If equipped, monitor the tilt alarm strobe carefully during operation. If the tilt alarm strobe flashes repeatedly during operation, this indicates that the tilt sensor has been triggered due to an unsafe tilt condition. This strobe is an indication only and will not shut off the unit.

### **ATTENTION!**

Although the geared adapter reverses the direction of the racking motor rotation, the CCM automatically corrects for this when a valid MBSL signal is present. Users can verify that a valid MBSL signal is present by the presence the upper or lower breaker location indication dot when the MBSL is connected.

When a valid MBSL signal is present users wishing to perform an Install operation will press and release the “INSTALL” button and users wishing to perform a Remove operation will press and release the “REMOVE” button.

10. When the racking operation has completed and the circuit breaker has stopped due to the applicable limit switch being triggered, the corresponding breaker location dot will illuminate on the CCM display to signal that the breaker is fully racked.
11. To remove the RRS-1 from the breaker, first disconnect all MBSL cables.
12. Next, turn the motor brake on the RRS-1 to the "OFF" position to relax the tension in the system so that the tool may be removed from the MBGA.
13. Turn off the RRS-1, release the floor locks, and carefully guide the unit away from the switchgear.
14. Next, disengage the engagement lever latch and allow the engagement lever to return to its normal position.

#### **ATTENTION**

The charging motor may begin to operate depending on the breaker's setup and the action performed.

15. Unhook the MBGA and close the cubicle door.
16. The RRS-1 is now disconnected from the switchgear and can be stored as directed until the next use.

#### ***1.4.1.2 MBSL Mode with Firmware Versions Prior to "v3.0" Operation***

1. Ensure that all components required for MBSL assisted operation have been properly installed as described in the previous section. Also ensure that all requirements listed in sections 1.2 and 1.3 have been met.
2. Verify that the circuit breaker is "OPEN" according to manufacturer specifications.
3. Power on the RRS-1 and ensure that the batteries are fully charged or that the unit is running on AC power.
4. Exit the arc flash boundary with the applicable pendant control (Either wired or wireless) to be used during remote operation and ensure that no personnel are present within the boundary prior to beginning the remote operation.

#### **DANGER!**

Exiting the arc-flash protection boundary may prevent the operator from observing the circuit breaker during repositioning and the problems that can occur during racking. Contact CBS ArcSafe® for remote monitoring solutions.

5. Using the appropriate control method (wired or wireless) press and release the "INSTALL" or "REMOVE" pushbutton to begin the racking procedure. The RRS-1 will begin the racking

procedure and continue until it automatically shuts off when the circuit breaker has been fully repositioned and the internal switches in the cubicle have been triggered.

### **DANGER!**

If equipped, monitor the tilt alarm strobe carefully during operation. If the tilt alarm strobe flashes repeatedly during operation, this indicates that the tilt sensor has been triggered due to an unsafe tilt condition. This strobe is an indication only and will not shut off the unit.

### **ATTENTION!**

Although the geared adapter reverses the direction of the racking motor rotation, the CCM automatically corrects for this when a valid MBSL signal is present. Users can verify that a valid MBSL signal is present by the presence the upper or lower breaker location indication dot when the MBSL is connected.

Therefore, when an valid MBSL signal is present users wishing to perform and Install operation will press and release the "INSTALL" button and users wishing to perform a Remove operation will press and release the "REMOVE" button.

6. When the racking operation has completed and the circuit breaker has stopped due to the applicable limit switch being triggered, the breaker is fully racked.
7. To remove the RRS-1 from the breaker, first disconnect all MBSL cables.
8. Next, turn the motor brake on the RRS-1 to the "OFF" position to relax the tension in the system so that the tool may be removed from the MBGA.
9. Turn off the RRS-1, release the floor locks, and carefully guide the unit away from the switchgear.
10. Next, disengage the engagement lever latch and allow the engagement lever to return to its normal position.

### **ATTENTION!**

The charging motor may begin to operate depending on the breaker's setup and the action performed.

11. Unhook the MBGA and close the cubicle door.
12. The RRS-1 is now disconnected from the switchgear and can be stored as directed until the next use.

## I.4.2 CCM Mode Operation

### **DANGER!**

The RRS-1 should not be used to rack a GE Magne-blast breaker in CCM mode on units equipped with MBSL; unless however the MBSL feature is not functioning properly and no other options exist for installing or removing the circuit breaker. CBS ArcSafe® ALWAYS recommends diagnosing and repairing problems within the cubicle to allow MBSL assisted remote racking to take place utilizing the built in limits within the Magne-blast cubicle. Racking in CCM mode is available as an alternative for defective cubicles only and should only be used as such. CBS ArcSafe® recommends using the RRS-1 only in switchgear known to be in proper working order. For more details please contact CBS ArcSafe®.

Please read the warning above before continuing any further. Operators using the RRS-1 to rack GE Magne-blast circuit breakers in CCM mode must understand that while operating in CCM mode the built in limit switches, which allow the breaker to rack to the correct position and then stop, will be disabled and the unit will run solely on current monitoring. If the CCM display on the RRS-1 does not display the applicable raised or lowered dot when the MBSL is connected (Firmware versions “v3.0” and higher only), this may indicate faulty control wiring within the cubicle. Users should be aware that faulty control power may also mean that other systems within the breaker are not working properly either. Please take caution when working in this situation.

### **DANGER!**

Before performing any electrical maintenance operation, please ensure that the proper plant operating procedures are always followed and all PPE requirements are met and/or followed.

### **I.4.2.1 Manual Current Control Operation**

Using manual current control allows users to monitor and record either the instantaneous or maximum current draw during the racking operation. This allows for quick and easy setting of the current control monitor for future automatic remote racking operations. In order to set the current control monitor to “manual” or “momentary” control, the Install and Remove current set points must be set to “0.0” amps. Perform the following steps to set the applicable Install and/or Remove set points to “0.0” amps and operate the RRS-1 in manual CCM mode:

1. Ensure that all components required for operation have been properly installed as described in the previous section. Also ensure that all requirements listed in sections I.2 and I.3 have been met.
2. Verify that the circuit breaker is “OPEN” according to manufacturer specifications.
3. If not already done, power on the RRS-1 and ensure that the batteries are fully charged or that the unit is running on AC power.
4. Next, setup the CCM to operate in manual mode. To set the CCM for manual RRS-1 operation, perform the following steps:

## ATTENTION!

The MBGA reverses the rotation direction of the RRS-1 drive motor. Therefore, when racking GE Magne-blast circuit breakers in CCM mode, users must setup and operate the RRS-1 in the opposite direction as the operation they wish to perform. This includes inputting CCM set points as well as remote operation using the pendant control.

For example: Users wishing to perform a REMOVE operation must input applicable set points for this operation by entering them in the INSTALL portion of the CCM interface. In addition, users must press the "INSTALL" button on the pendant controller to perform the remove operation.

- a. Press and hold the "INSTALL" or "REMOVE" soft pushbuttons on the CCM (NOT the "INSTALL" or "REMOVE" buttons on the pendant control) corresponding to the OPPOSITE operation to be performed while at the same time pressing the "DOWN" soft pushbutton on the CCM until a value of "0.0" amps is reached.
  - b. Once complete, users may now setup the CCM to store the maximum current draw during the racking operation by pressing the "DOWN/MAX CURRENT" button before operating the RRS-1. When this function is active, the decimal point on the CCM display will begin to blink. The CCM display will now display the maximum current drawn during an operation and not the instantaneous current draw as it normally would. The internal memory of the CCM will retain this maximum value of current recorded during the operation until it is reset. To reset this value from the pendant control, simply begin a new operation. To reset this value from the CCM, press the same button once to clear the current value, and then again to begin monitoring max current for the next operation.
5. Once the RRS-1 has been setup to operate in manual mode, users may now exit the arc flash boundary with the pendant control (Either wired or wireless) to be used during remote operation. Ensure that no personnel are present within the boundary prior to beginning the remote operation.

## DANGER!

Ensure that while using the RRS-1 in manual mode all service personnel remain outside the arc-flash boundary and comply with all applicable Federal, State, Local, and In-house safety regulations and procedures regarding arc-flash. CBS ArcSafe® offers several options which allow viewers to view the CCM display reading and/or the racking operations remotely if the operator is not in a position to view the racking operation.

6. Using the appropriate control method (wired or wireless) press and hold the "INSTALL" or "REMOVE" pushbutton on the pendant control which corresponds to the OPPOSITE operation the user wishes to perform to rack the breaker to the desired location. The remote racking operation may be stopped at any time by releasing the pushbutton on the pendant control
7. Carefully monitor breaker location during this process, as there is no automatic stop for motor operation during this particular process. Therefore, the motor will continue to operate as long as the command is being given.

## **DANGER!**

Due to the nature of the operation being performed, it is possible to over-rack the circuit breaker and damage equipment. Always monitor breaker location during this process to prevent over-racking the breaker or damaging equipment.

8. Please record the maximum value attained during this process. This value will aid in setting up the RRS-1 for automatic current control operation.

## **ATTENTION!**

The internal memory of the current control monitor will retain the highest value recorded for a minimum of 1 minute. (Times will vary based on CCM firmware version installed)

9. When the circuit breaker racking operation is complete, the RRS-1 can be uninstalled from the circuit breaker and stored.

### ***1.4.2.2 Automatic Current Control Operation***

After racking a GE Magne-blast in manual CCM mode using the RRS-1, users should have recorded a value of maximum current required to perform both install and remove operations. With these maximum required values known, operators can now input applicable set points for install and remove operations into the CCM which will enable the RRS-1 to run automatically for future operations. See Section 1.4.2.1 for procedures for running the RRS-1 in manual mode with the MBGA.

1. Ensure that all components required for operation have been properly installed as described in the previous section. Also ensure that all requirements listed in sections 1.2 and 1.3 have been met.
2. Verify that the circuit breaker is "OPEN" according to manufacturer specifications.
3. If not already done, power on the RRS-1 and ensure that the batteries are fully charged or that the unit is running on AC power.
4. Next, setup the CCM to operate in automatic mode. To set the CCM for automatic RRS-1 operation, perform the following steps:

## **ATTENTION!**

The MBGA reverses the rotation direction of the RRS-1 drive motor. Therefore, when racking GE Magne-blast circuit breakers in CCM mode, users must setup and operate the RRS-1 in the opposite direction as the operation they wish to perform. This includes inputting CCM set points as well as remote operation using the pendant control.

For example: Users wishing to perform a REMOVE operation must input applicable set points for this operation by entering them in the INSTALL portion of the CCM interface. In addition, users must press the "INSTALL" button on the pendant controller to perform the remove operation.

- a. The best method in determining a suitable current limit setting is by predetermining the maximum required current to complete an the operation by operating the RRS-1 in manual mode the first time a breaker is installed and/or removed this way and recording the maximum value attained.

### ATTENTION!

At this point, recall the highest value recorded during manual racking operation from Section I.4.2.1 for the applicable install or remove operation. Set the CCM value approximately 10-20% higher than the maximum value recorded to begin.

The required current setting is determined by a number of factors including breaker type, size, environment, and physical condition. The 10-20% increase in current is only a guideline and may not apply to the equipment being operated.

- b. Press and hold the applicable "INSTALL" or "REMOVE" soft pushbuttons on the CCM (NOT the "INSTALL" or "REMOVE" buttons on the pendant control) corresponding to the OPPOSITE operation to be performed while at the same time pressing the "UP" or "DOWN" soft pushbuttons on the CCM until the desired value is reached.
  - c. After the desired set points have been entered, users may now setup the CCM to store the maximum current draw during the racking operation by pressing the "DOWN/MAX CURRENT" button before operating the RRS-1. When this function is active, the decimal point on the CCM display will begin to blink. The CCM display will now display the maximum current drawn during an operation and not the instantaneous current draw as it normally would. The internal memory of the CCM will retain this maximum value of current recorded during the operation until it is reset. To reset this value from the pendant control, simply begin a new operation. To reset this value from the CCM, press the same button once to clear the current value, and then again to begin monitoring max current for the next operation.
5. After the applicable set points have been entered into the CCM, users may now exit the arc flash boundary with the pendant control (Either wired or wireless) to be used during remote operation. Ensure that no personnel are present within the boundary prior to beginning the remote operation.
  6. Press and release the "INSTALL" or "REMOVE" pushbutton on the pendant control which corresponds to the OPPOSITE operation the user wishes to perform. The RRS-1 unit will continue the racking operation until the current draw on the system reaches the current set point, at which point the system will cease operation. The remote racking operation may be stopped at any time by pressing the opposite "INSTALL" or "REMOVE" pushbutton on the pendant control.
  7. If the CCM install and/or remove set points have been set to an accurate value for the equipment being operated, the racking operation will stop when the switchgear reaches the applicable disconnected or connected position.
  8. When the circuit breaker racking operation is complete, the RRS-1 can be uninstalled from the circuit breaker and stored.

## Appendix J: Transport Assist

This section will describe the components and the application of Transport Assist attachment.

### J.1 Components

The travel assist attachment assists users in transporting the RRS-1 across flat, level surfaces by allowing the unit to rest on extendable legs with locking wheels during transport. This upgrade consists of a pair of locking legs with wheels, with one being mounted to each side of the RRS-1 unit onto the upright hoops. An RRS-1 equipped with this option is shown in the following figure.



**Figure J-1:** Transport Assist attachment installed on RRS-1



## J.2 Application

### **DANGER!**

Be sure that the RRS-1 is turned OFF, and that the drive motor is positioned on the lower third of the slide rail before attempting to use the Transport Assist.

Failure to properly position the drive motor before utilizing the Transport Assist may unbalance the RRS-1, resulting in unexpected tipping of the unit and serious injury.

### **ATTENTION!**

The Transport Assist attachment is suitable for use on smooth, flat surfaces only. Rough or uneven surfaces may damage the wheels on the Transport Assist attachment.

Follow the procedure below to transport the RRS-1 using the Transport Assist Attachment:

1. Ensure that the RRS-1 unit is powered down and that all tooling or accessories are removed from the machine.
2. Ensure that the drive motor is positioned on the lower third of the slide rail.
3. Next, make sure that all attached coil cords and/or pendants are secured to the machine properly in such a way that they will not come loose during transport.
4. Ensure that the storage bag is zipped closed so that the contents do not accidentally fall out during transport.
5. Check to see that the control cabinet access door in the rear of the machine is closed securely so that it will not open during transport.
6. To deploy the Transport Assist for use:
  - a. For each of the Transport Assist legs, depress the lock pin to release the leg, then pull the leg out from the RRS-1.



**Figure J-2:** Deploying the Transport Assist leg

- b. Once the leg has reached the second lock pin, depress this pin and continue pulling the leg away from the RRS-1 until it locks in place.



**Figure J-3:** Transport Assist leg locked in place

- c. Next, tilt the machine back until it comes to rest on the Transport Assist wheels.



**Figure J-4:** Transport Assist in use

7. To stow the Transport Assist after use:
  - a. First, tilt the machine forward until it comes to rest on both its front and rear wheels.
  - b. For each of the Transport Assist legs, press in the lock pin to release the leg then push the leg in toward the RRS-1.



**Figure J-5:** Unlocking the Transport Assist leg for stowing

- c. Once the leg has reached the second lock pin, depress this pin and continue pushing the leg toward the RRS-1 until it locks in place.



**Figure J-6:** Transport Assist leg stowed

8. Once complete, inspect the RRS-1 to ensure that no damage was suffered during the process.

# Appendix K: PD Alert

This section describes the components and the application of PD Alert accessory.

## K.1 Components

PD Alert is a first-indication alert of the presence of partial discharge in electrical equipment. It utilized radio-frequency emissions to detect the presence of moderate to severe insulation-damaging partial discharge in electrical circuit breakers.

### **DANGER!**

Breaker insulation that has been fatigued by partial discharge has an increased likelihood of breaking down and causing an arc-flash incident.

Exercise extreme caution when racking a breaker that shows signs of active partial discharge.

The PD Alert system consists of three main components, illustrated below.

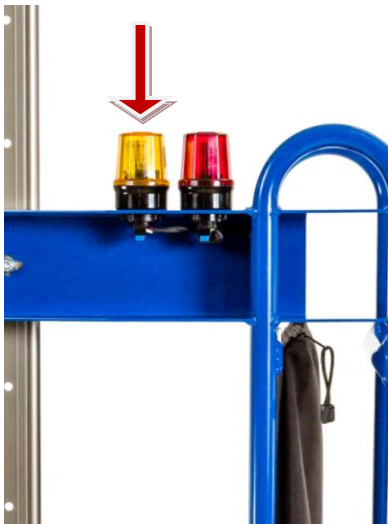

PD Alert Beacon



Sensing Element



PD Alert Feature Switch

## K.2 Application

### ATTENTION:

Depending on the operating environment, the PD Alert accessory may need to be recalibrated prior to use.

The PD Alert sensor will be properly calibrated on-site by a CBS ArcSafe representative at the time of training for the RRS-1. For any questions regarding setup or calibration of PD Alert, please contact CBS ArcSafe.

To utilize the PD Alert accessory, do the following:

1. Position the RRS-1 in front of the equipment to be operated or inspected.
2. Turn on the Main Disconnect of the RRS-1.
3. Turn on the PD Alert feature switch.

### NOTE:

PD Alert requires approximately 3 seconds to complete a reading. PD Alert should be allowed to run for at least 10 seconds to ensure an accurate reading is collected.

PD Alert has a sensing range of approximately 10ft (3m), depending on the partial discharge strength.

- a. If the Alert beacon light illuminates, then PD Alert is detecting a partial discharge signal in the immediate area.
  - b. If the Alert beacon light does not illuminate, then PD Alert does not detect a partial discharge signal in the immediate area.
4. Turn PD Alert back off before operating the RRS-1.



















*Distance Is Safety*®

A Group CBS Company

RRS-1  
Technical Manual

2616 Sirius Road  
Denton, TX 76208  
Tel: 877-4-SAFETY  
Fax: 940-382-9435  
Website: [www.CBSArcSafe.com](http://www.CBSArcSafe.com)  
Email: [info@CBSArcSafe.com](mailto:info@CBSArcSafe.com)

**DANGER!**

Ensure that personnel using this equipment are adequately trained in the operation of the switchgear they are planning to work with; that they are correctly stationed outside the arc flash boundary; and that they comply with all applicable Federal, State, Local, and In-house safety regulations and procedures. Attention should be given to distance, angle, and personal protective equipment.